

REF. ASSEMBLY

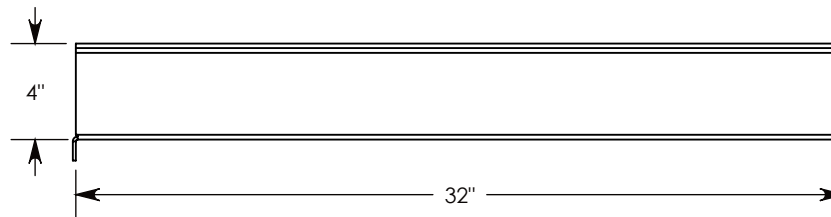
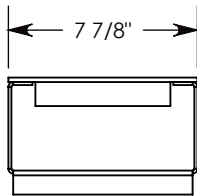
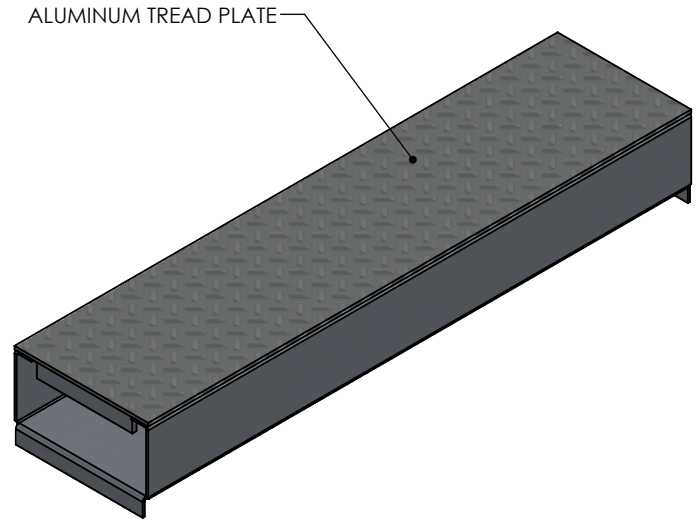
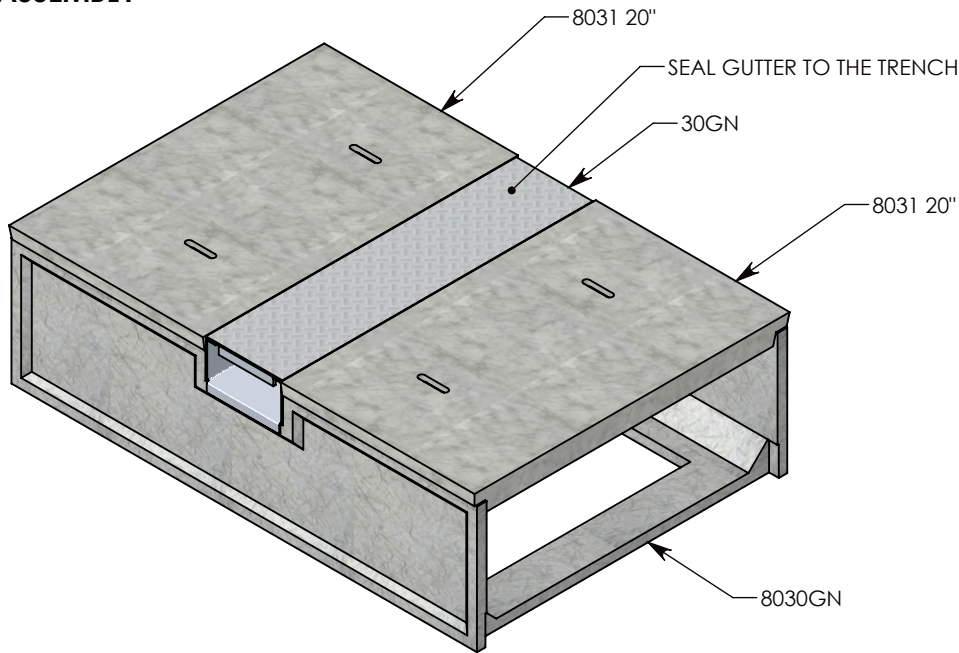

NOTE 1: FITS A 8030GN OR A 803016GN CHANNEL.

NOTE 2: SEAL THE GAP BETWEEN NOTCH & CHANNEL IN THE FIELD.

PEDESTRIAN RATED - 200 LB. PER SQ. FOOT

DRAWN BY: ROSS LAGER

DATE: 6/14/2018

REVISION LEVEL: A

WEIGHT:

12 LBS.

MATERIAL:

WELDED ALUMINUM



DESCRIPTION:

GUTTER NOTCH

DIMENSIONS ARE IN INCHES
TOLERANCES:
FRACTIONAL: $\pm 1/8"$
ANGULAR: $\pm 2^\circ$

CONTACT INFORMATION:
EMAIL: INFO@CONCASTINC.COM
PHONE: (507) 732-4095
FAX: (507) 732-4094

SHEET 1 OF 1

PART NUMBER:

30GN