

ALUMINUM TREAD PLATE

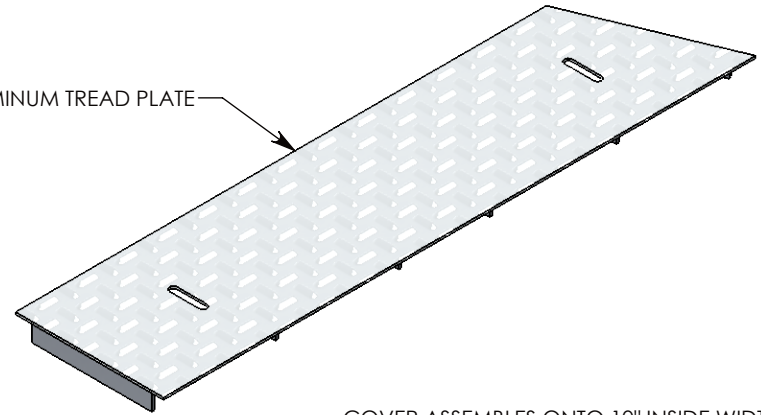

COVER ASSEMBLES ONTO 10" INSIDE WIDTH
PEDESTRIAN RATED CONCAST CHANNEL

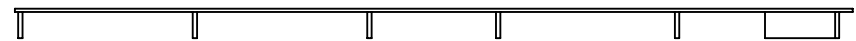

NOTE 1: FOR NON-STANDARD LENGTHS THE PART NUMBER WILL CORRESPOND TO ITS MEASURED LENGTH. IE: 8011A 22.5L 24"

PEDESTRIAN RATED - 300 LB. PER SQ. FOOT

DRAWN BY: JESSE GUTTING	
CREATED DATE: 3/22/2010	REVISION LEVEL: A
SAVED DATE: 4/27/2020	SAVED BY: jgutting
WEIGHT: 13 LBS.	MATERIAL: WELDED ALUMINUM

CONCAST
1010 NORTH STAR DRIVE
P.O. BOX 69
ZUMBROTA, MN 55992-0069

DESCRIPTION: PED ALUM COVER - 22.5 DEGREE ANGLE		SHEET 1 OF 2
DIMENSIONS ARE IN INCHES TOLERANCES: FRACTIONAL: ± 1/8" ANGULAR: ± 2°	CONTACT INFORMATION: EMAIL: INFO@CONCASTINC.COM PHONE: (507) 732-4095 FAX: (507) 732-4094	
PART NUMBER: 8011A 22.5L		