

FIBERCRETE[®]
TRENCH
SYSTEM

REFERENCE ASSEMBLY

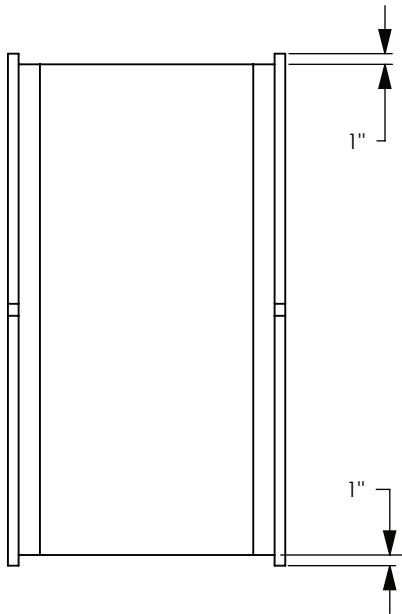

802416HT ETC.
16" INSIDE DEPTH
HEAVY TRAFFIC
CHANNEL

TBH 22.5 - TRANSITIONAL
BULK HEAD 22.5" LG (2X)

802416 ETC.
16" INSIDE DEPTH
PEDESTRIAN CHANNEL

802416DRT

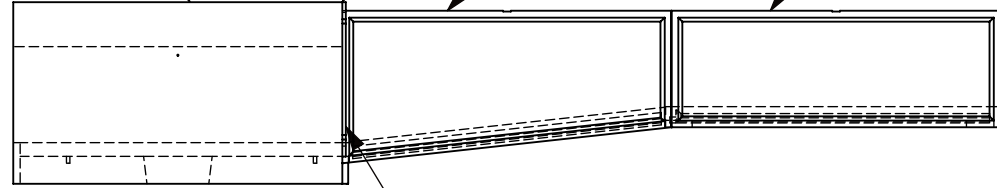

USE VULKEM POLYURETHANE
SEALANT TO ATTACH & SEAL
THE BULK HEADS TO THE ROAD
CHANNEL WHEN ASSEMBLING
THE TRENCH SYSTEM.

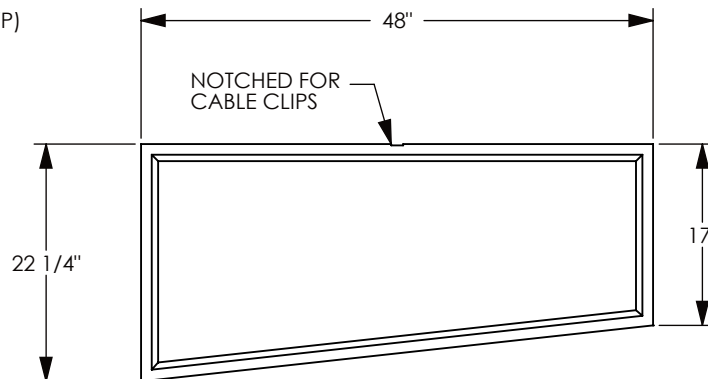
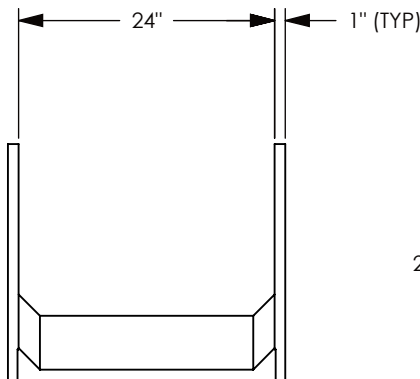

FIBER & STEEL
REINFORCED
CONCRETE

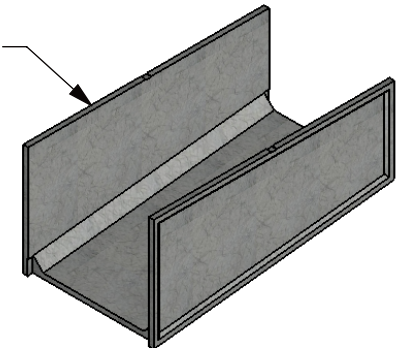

PEDESTRIAN RATED - 200 LB. PER SQ. FOOT

DRAWN BY: ROBIN FLINT

DATE: 12/19/2011

REVISION LEVEL: 0

WEIGHT:

163 LBS.

MATERIAL:

FIBERCRETE

CONCAST
 1010 NORTH STAR DRIVE
 P.O. BOX 69
 ZUMBROTA, MN 55992-0069

DESCRIPTION:

TRANSITION CHANNEL

DIMENSIONS ARE IN INCHES
 TOLERANCES:
 FRACTIONAL: ± 1/8"
 ANGULAR: ± 2°

CONTACT INFORMATION:
 EMAIL: INFO@CONCASTINC.COM
 PHONE: (507) 732-4095
 FAX: (507) 732-4094

SHEET 1 OF 1

PART NUMBER:

802416DRT