

COVER ASSEMBLES ONTO 24" INSIDE WIDTH
HEAVY TRAFFIC H-40 RATED CONCAST CHANNEL

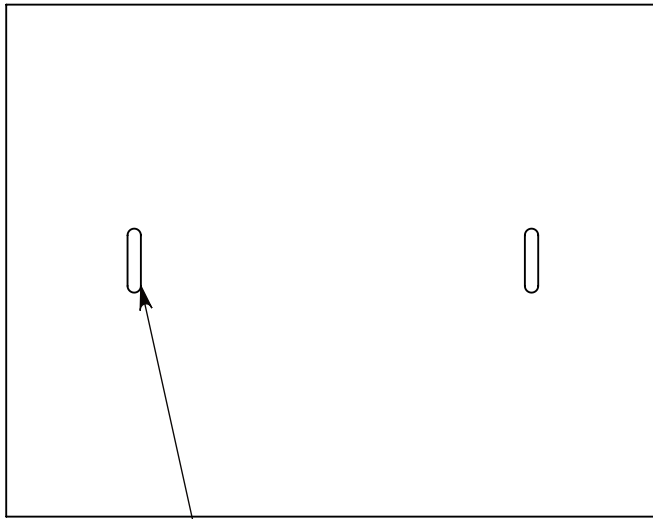

LIFTING SLOT (2X)

GALVANIZED STEEL TREAD PLATE
(SEE NOTE 2)

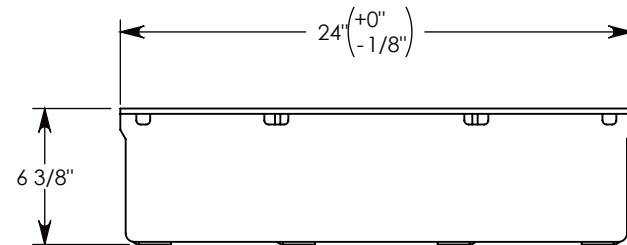
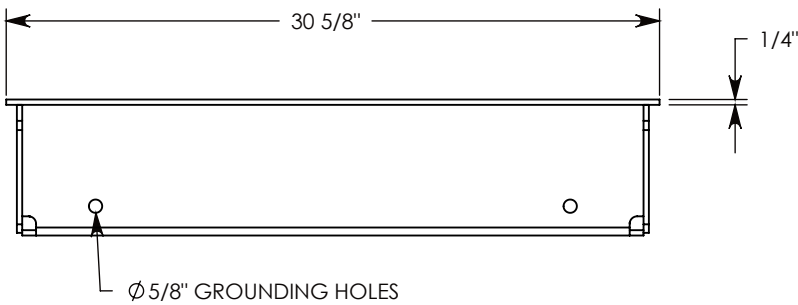
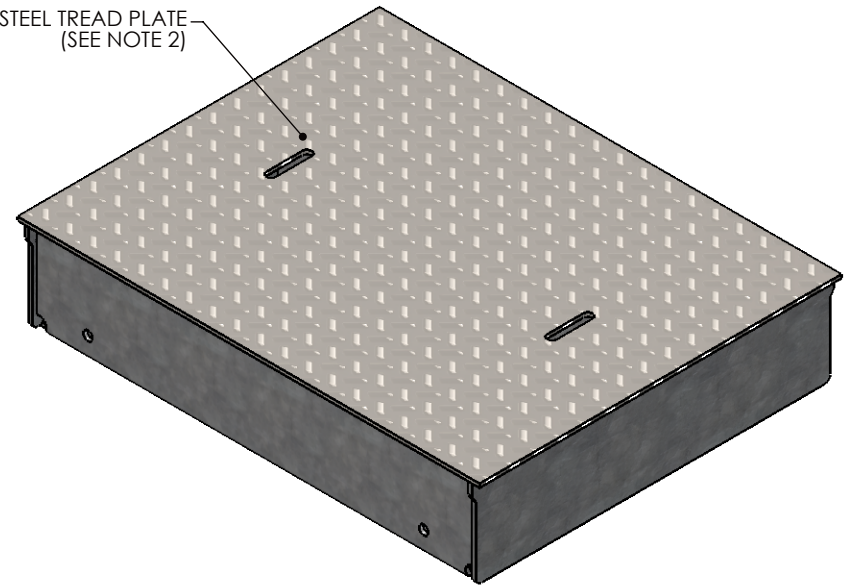

NOTE 1: FOR NON-STANDARD LENGTHS THE PART NUMBER WILL CORRESPOND TO IT'S MEASURED LENGTH. IE: 8025HTSG40 16"
NOTE 2: TREAD ON DIAMOND PLATE ADDS 1/8" TO OVERALL HEIGHT

AASHTO H-40 RATED - 64,000 LB. SINGLE AXLE LOAD

DRAWN BY: JESSE GUTTING	
CREATED DATE: 3/21/2011	REVISION LEVEL: 0
SAVED DATE: 11/7/2019	SAVED BY: JGUTTING
WEIGHT: 139 LBS.	MATERIAL: GALVANIZED STEEL

CONCAST
1010 NORTH STAR DRIVE
P.O. BOX 69
ZUMBROTA, MN 55992-0069

DESCRIPTION: HEAVY TRAFFIC GALV. STEEL COVER	
DIMENSIONS ARE IN INCHES TOLERANCES: FRACTIONAL: ± 1/8" ANGULAR: ± 2°	CONTACT INFORMATION: EMAIL: INFO@CONCASTINC.COM PHONE: (507) 732-4095 FAX: (507) 732-4094
PART NUMBER: 8025HTSG40	
SHEET 1 OF 2	