

FIBERCRETE[®]
TRENCH SYSTEM

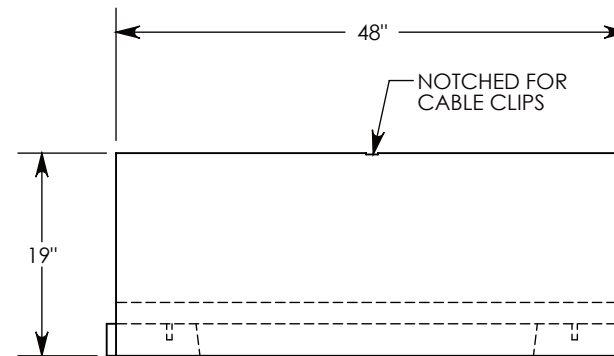
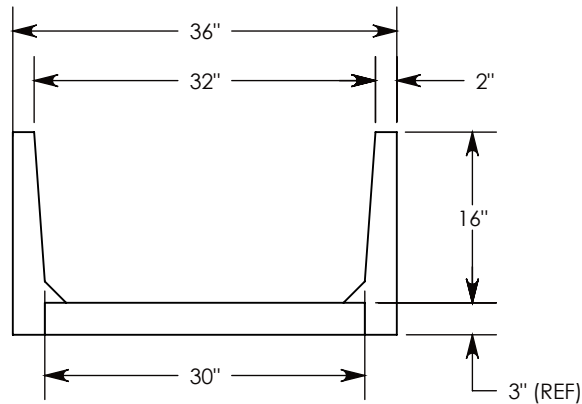
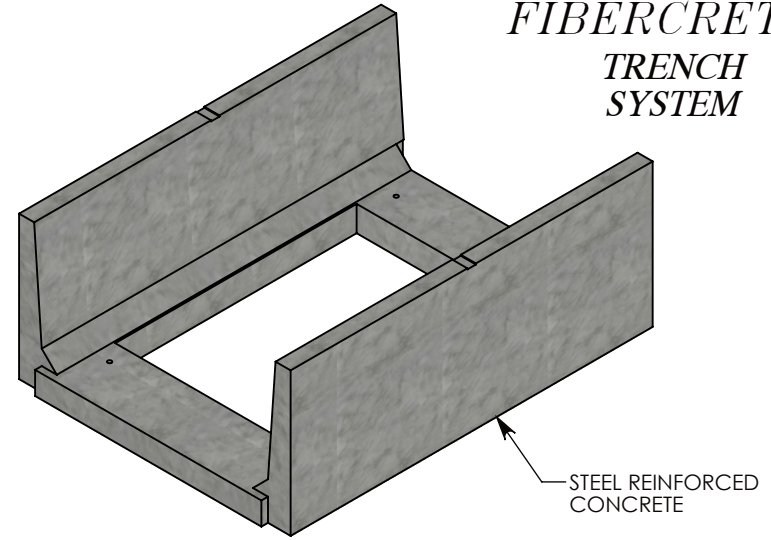
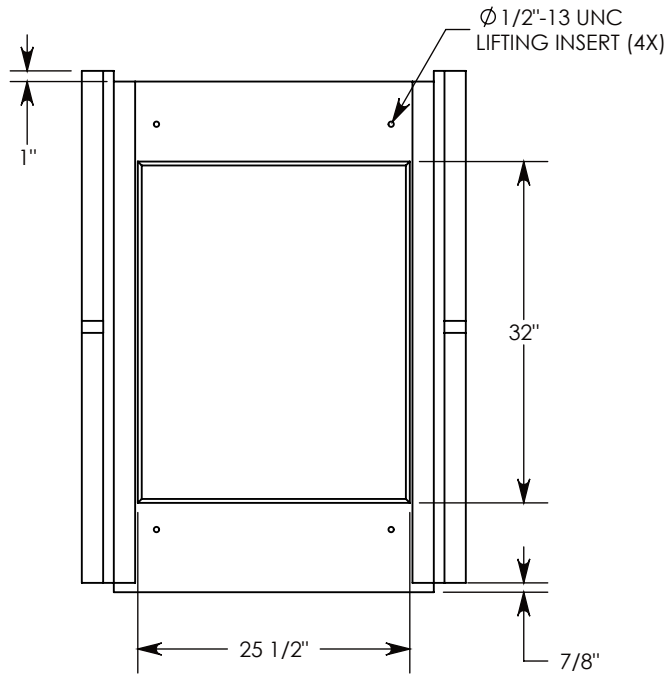

NOTE: FOR NON-STANDARD LENGTHS THE CHANNEL WILL BE SOLID BOTTOM AND DESIGNATED WITH ITS CORRESPONDING LENGTH MEASUREMENT. IE: 803016PT 32"

PEDESTRIAN RATED - 200 LB. PER SQ. FOOT

DRAWN BY: ROBIN FLINT

DATE: 3/1/2016

REVISION LEVEL: 0

WEIGHT:

597 LBS.

MATERIAL:

NOTED

CONCAST
 1010 NORTH STAR DRIVE
 P.O. BOX 69
 ZUMBROTA, MN 55992-0069

DESCRIPTION:

PEDESTRIAN CHANNEL

DIMENSIONS ARE IN INCHES
 TOLERANCES:
 FRACTIONAL: ± 1/8"
 ANGULAR: ± 2°

CONTACT INFORMATION:
 EMAIL: INFO@CONCASTINC.COM
 PHONE: (507) 732-4095
 FAX: (507) 732-4094

SHEET 1 OF 1

PART NUMBER:

803016PT