

FIBERCRETE[®]
TRENCH
SYSTEM

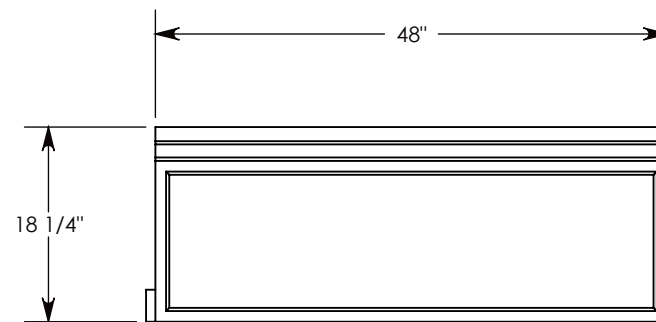
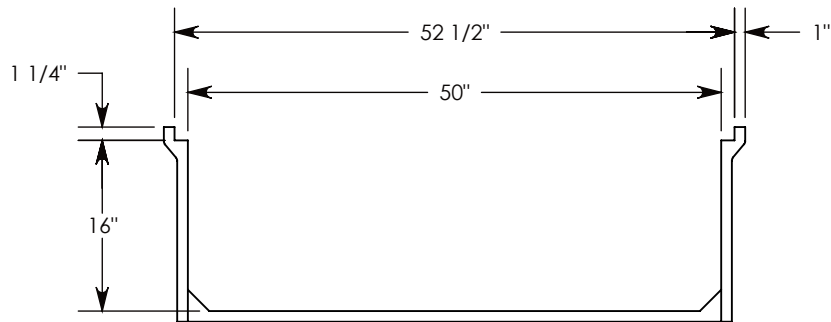
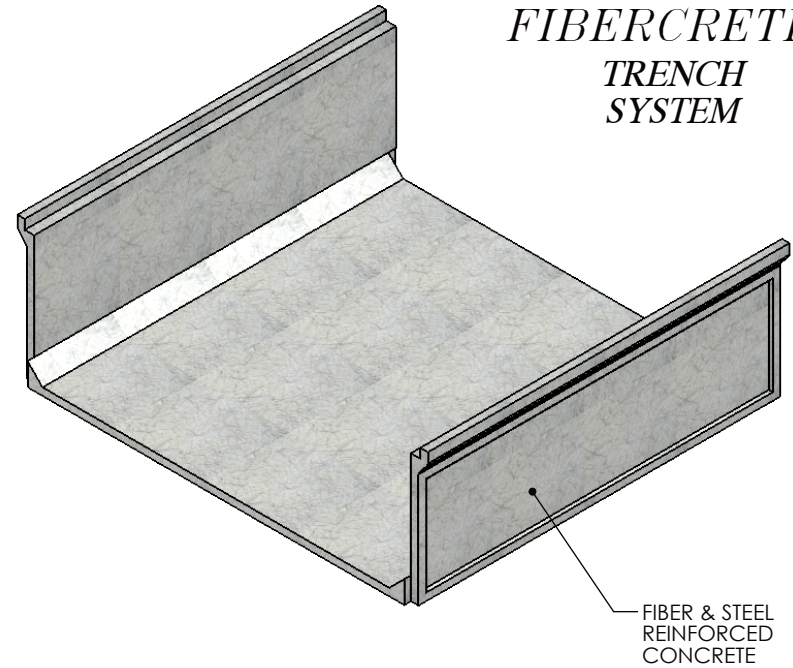
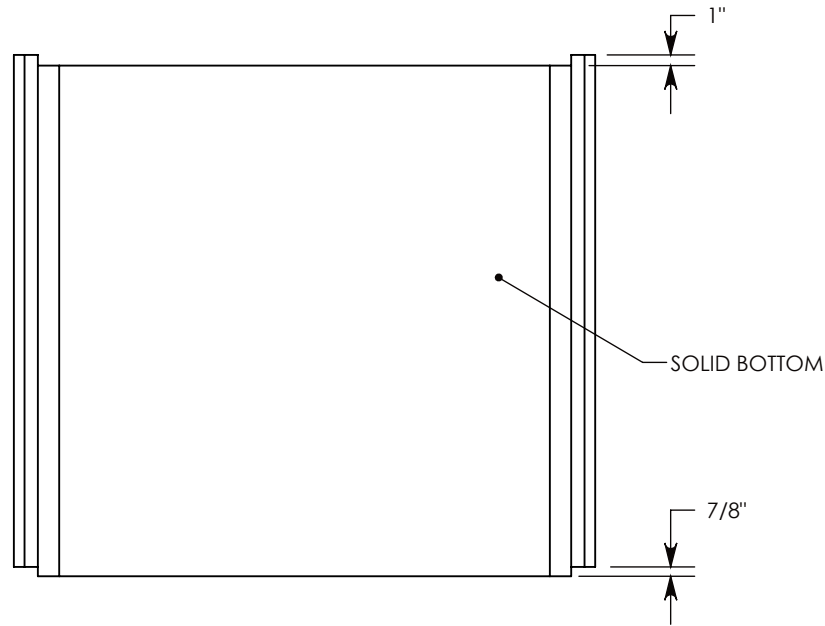

NOTE: FOR NON-STANDARD LENGTHS THE CHANNEL WILL BE DESIGNATED WITH ITS CORRESPONDING LENGTH MEASUREMENT. IE: 805016FSB 32"

PEDESTRIAN RATED - 200 LB. PER SQ. FOOT

DRAWN BY: ROBIN LEWIS	
DATE: 2/23/2017	REVISION LEVEL: 0
WEIGHT: 301 LBS.	MATERIAL: NOTED



CONCAST
 1010 NORTH STAR DRIVE
 P.O. BOX 69
 ZUMBROTA, MN 55992-0069

DESCRIPTION: FLUSH PEDESTRIAN CHANNEL		
DIMENSIONS ARE IN INCHES TOLERANCES: FRACTIONAL: ± 1/8" ANGULAR: ± 2°	CONTACT INFORMATION: EMAIL: INFO@CONCASTINC.COM PHONE: (507) 732-4095 FAX: (507) 732-4094	SHEET 1 OF 1
PART NUMBER: 805016FSB		