

FIBERCRETE[®]
TRENCH
SYSTEM

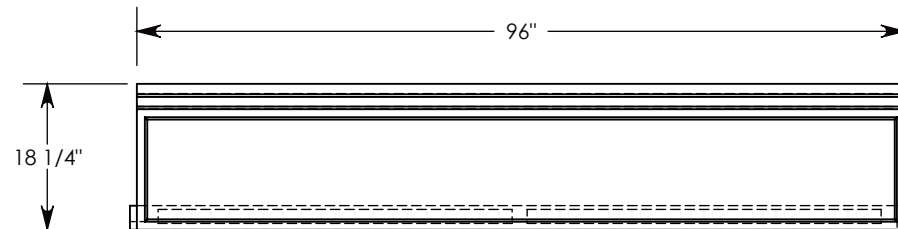
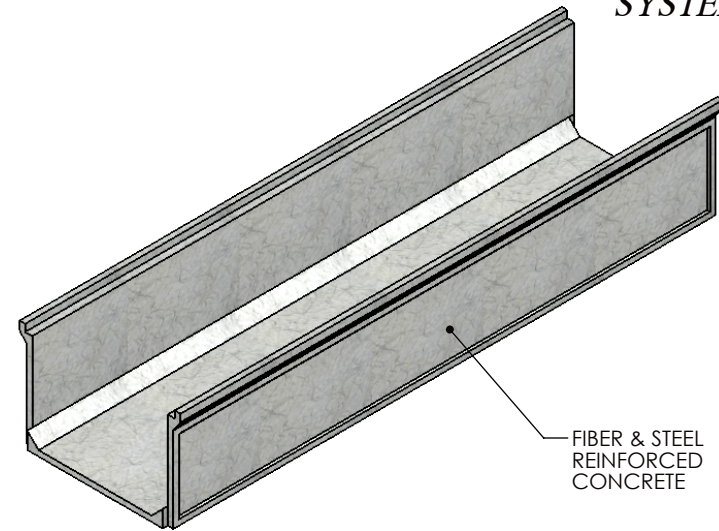
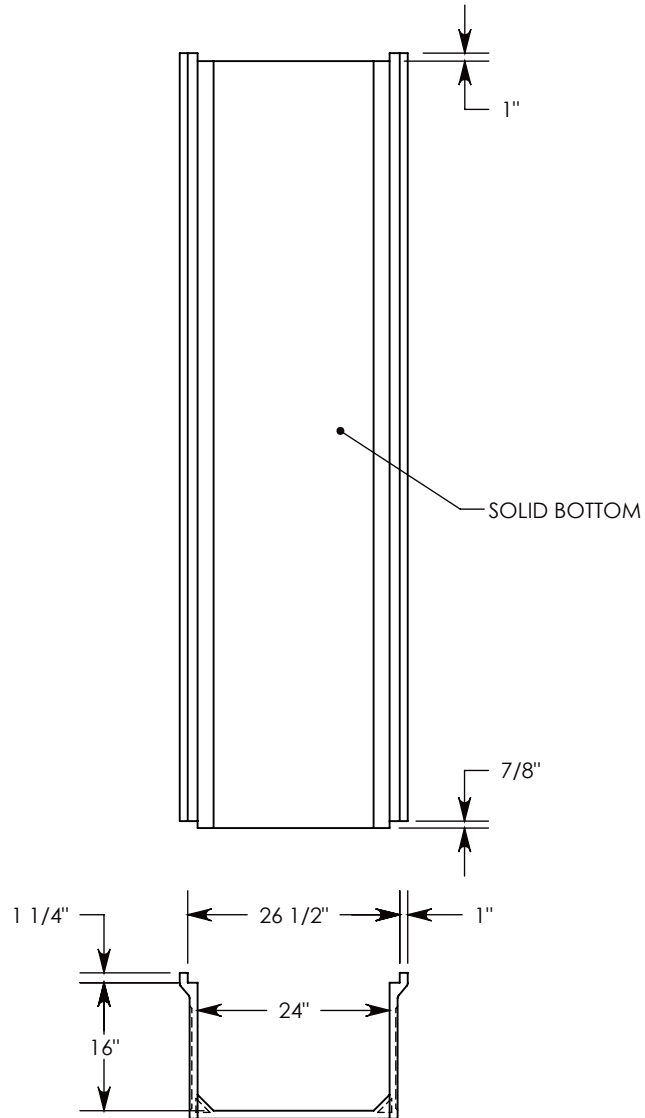

NOTE: FOR NON-STANDARD LENGTHS THE CHANNEL WILL BE DESIGNATED WITH ITS CORRESPONDING LENGTH MEASUREMENT. IE: 882416FSB 32"

PEDESTRIAN RATED - 200 LB. PER SQ. FOOT

DRAWN BY: ROBIN LEWIS

DATE: 2/23/2017

REVISION LEVEL: 0

WEIGHT:

414 LBS.

MATERIAL:

NOTED



DESCRIPTION:

FLUSH PEDESTRIAN CHANNEL

DIMENSIONS ARE IN INCHES
 TOLERANCES:
 FRACTIONAL: ± 1/8"
 ANGULAR: ± 2°

CONTACT INFORMATION:
 EMAIL: INFO@CONCASTINC.COM
 PHONE: (507) 732-4095
 FAX: (507) 732-4094

SHEET 1 OF 1

PART NUMBER:

882416FSB