

**FIBERCRETE<sup>®</sup>**  
**TRENCH**  
**SYSTEM**

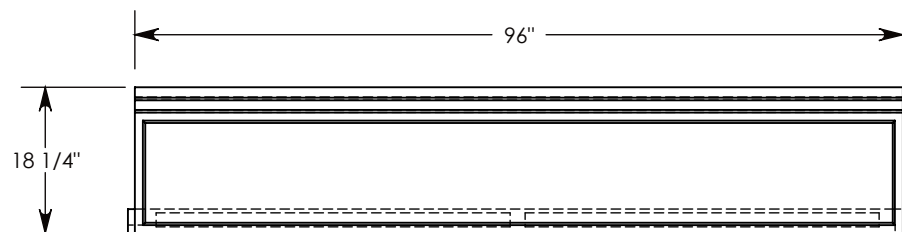
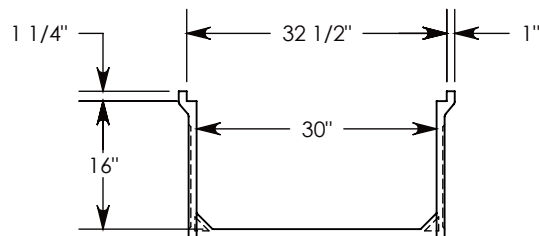
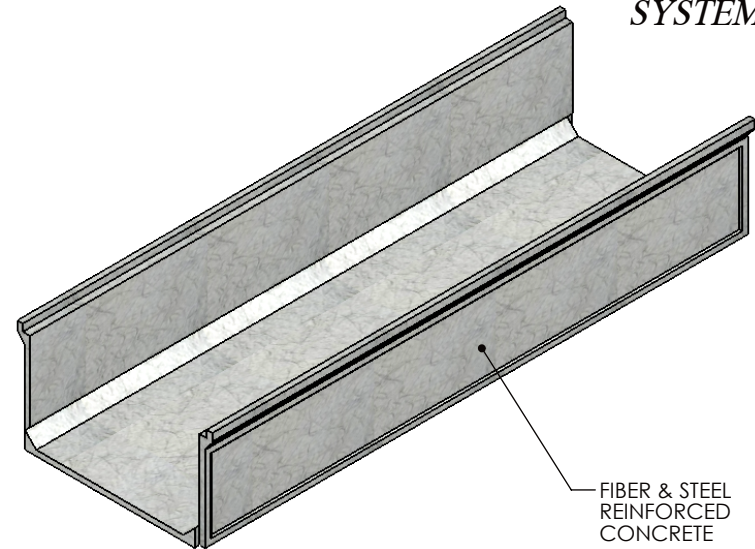
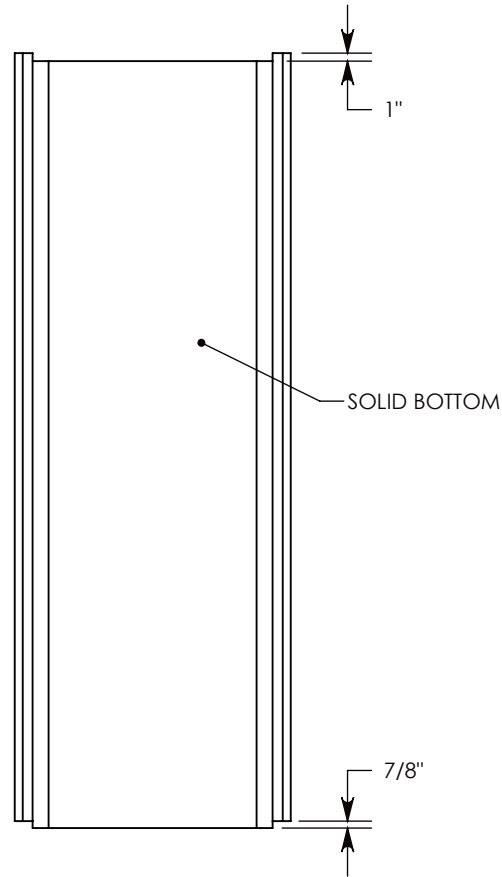

NOTE: FOR NON-STANDARD LENGTHS THE CHANNEL WILL BE DESIGNATED WITH ITS CORRESPONDING LENGTH MEASUREMENT. IE: 883016FSB 32"

PEDESTRIAN RATED - 200 LB. PER SQ. FOOT

**DRAWN BY: ROBIN LEWIS**

**DATE: 2/23/2017**

**REVISION LEVEL: 0**

**WEIGHT:**

**456 LBS.**

**MATERIAL:**

**NOTED**



**DESCRIPTION:**

**FLUSH PEDESTRIAN CHANNEL**

DIMENSIONS ARE IN INCHES  
 TOLERANCES:  
 FRACTIONAL:  $\pm 1/8"$   
 ANGULAR:  $\pm 2^\circ$

CONTACT INFORMATION:  
 EMAIL: [INFO@CONCASTINC.COM](mailto:INFO@CONCASTINC.COM)  
 PHONE: (507) 732-4095  
 FAX: (507) 732-4094

SHEET 1 OF 1

**PART NUMBER:**

**883016FSB**