

**FIBERCRETE<sup>®</sup>**  
**TRENCH**  
**SYSTEM**

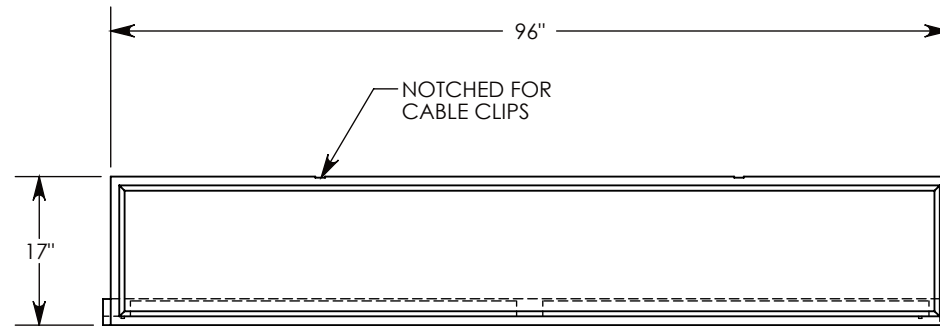
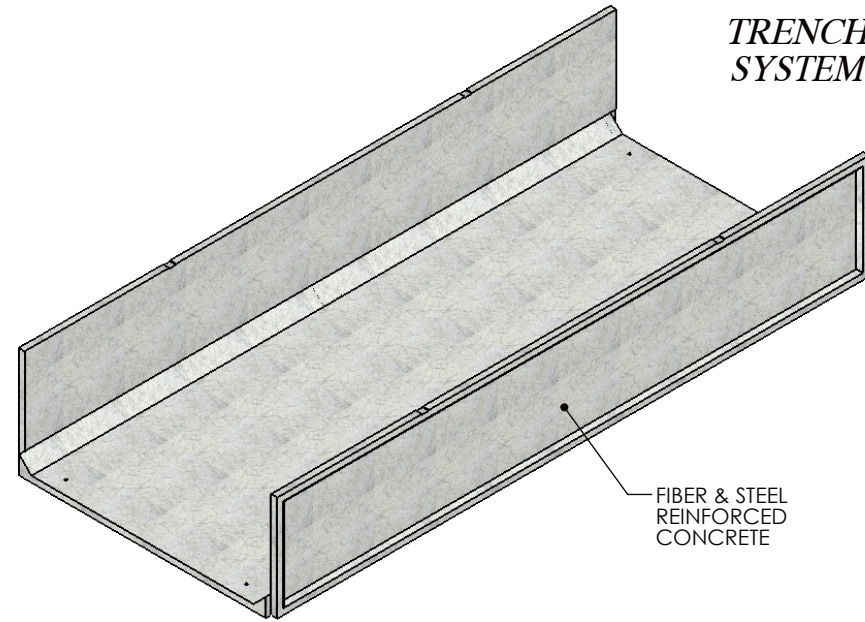
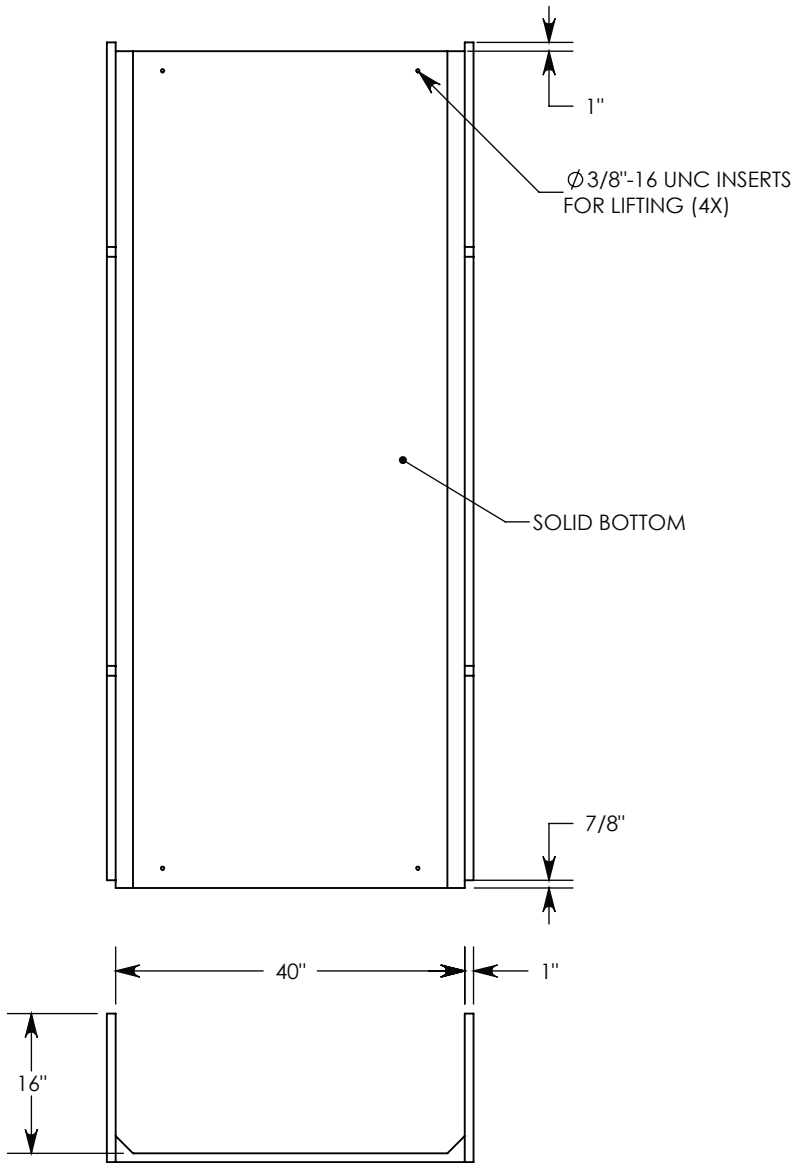

NOTE: FOR NON-STANDARD LENGTHS THE CHANNEL WILL BE DESIGNATED WITH ITS CORRESPONDING LENGTH MEASUREMENT. IE: 884016SB 32"

PEDESTRIAN RATED - 200 LB. PER SQ. FOOT

**DRAWN BY: ROBIN FLINT**

**DATE: 2/17/2017**

**REVISION LEVEL: 0**

**WEIGHT:**

**451 LBS.**

**MATERIAL:**

**NOTED**



1010 NORTH STAR DRIVE  
P.O. BOX 69  
ZUMBROTA, MN 55992-0069

**DESCRIPTION:**

**PEDESTRIAN CHANNEL**

DIMENSIONS ARE IN INCHES  
TOLERANCES:  
FRACTIONAL: ± 1/8"  
ANGULAR: ± 2°

CONTACT INFORMATION:  
EMAIL: INFO@CONCASTINC.COM  
PHONE: (507) 732-4095  
FAX: (507) 732-4094

SHEET 1 OF 1

**PART NUMBER:**

**884016SB**