

ITEM NO.	PART NUMBER	DESCRIPTION	QTY.
1	CCSCREW-1.25	1/4" X 1.25" LONG CONCRETE SCREW	8
2	DIV-BKT.W	1/2" ALUMINUM SLEEVE	4
3	FHR-30-30-DIV.B	FHR DIVIDER BOARD	1

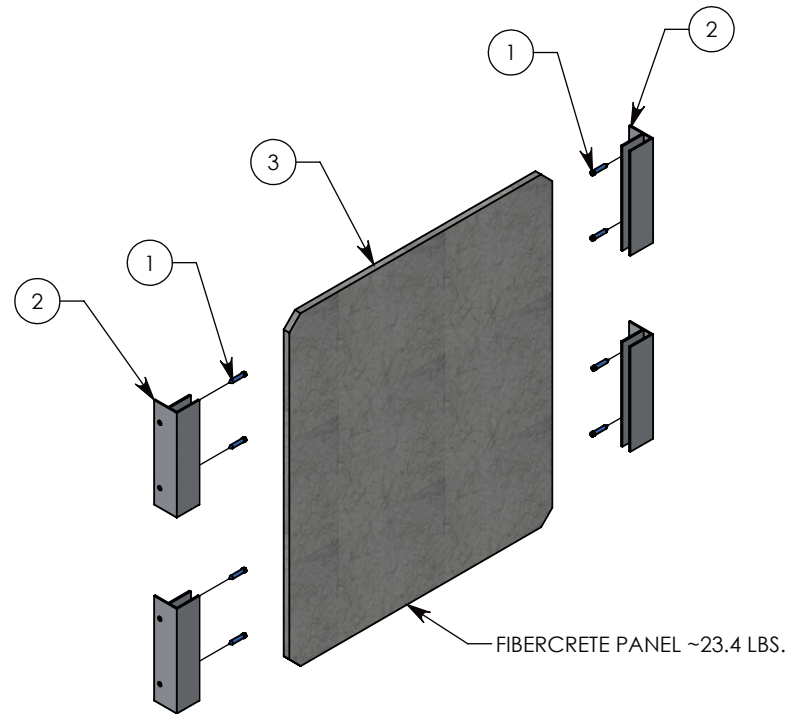

**NOTE:** DESIGNED TO CREATE SEPARATION IN A 30" WIDE BY 30" TALL CONCAST FHR HANDHOLE UNIT.

<b>DRAWN BY: ROBIN FLINT</b>	
<b>DATE: 10/31/2015</b>	<b>REVISION LEVEL: 0</b>
<b>WEIGHT: 26 LBS. WITH HARDWARE</b>	<b>MATERIAL: NOTED</b>

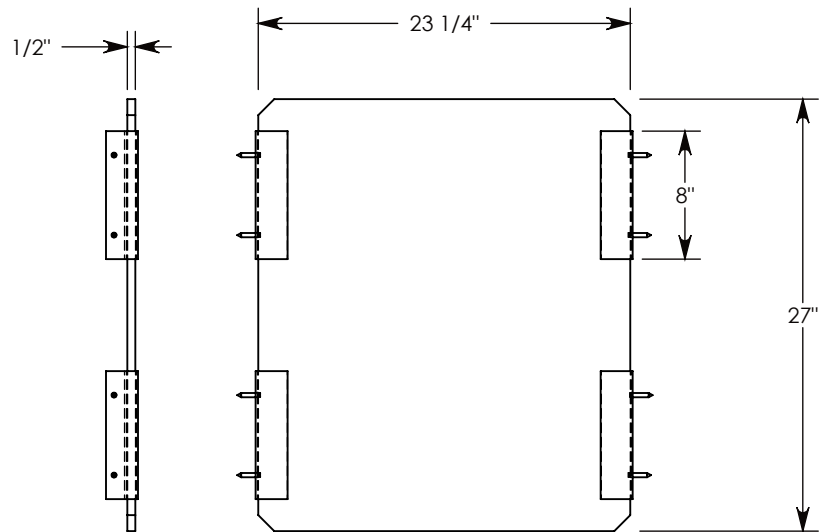

1010 NORTH STAR DRIVE  
P.O. BOX 69  
ZUMBROTA, MN 55992-0069

<b>DESCRIPTION:</b>		<b>FHR DIVIDER PANEL</b>
DIMENSIONS ARE IN INCHES TOLERANCES: FRACTIONAL: ± 1/8" ANGULAR: ± 2°	CONTACT INFORMATION: EMAIL: INFO@CONCASTINC.COM PHONE: (507) 732-4095 FAX: (507) 732-4094	SHEET 1 OF 1
<b>PART NUMBER:</b>		<b>FHR-30-30-DIV</b>