

PART NUMBER	"XX" OVERALL HEIGHT	"X" AMOUNT OF EXTENSION	WEIGHT (POUNDS)
FHREXSLP-18-30-12	12"	9.5"	244
FHREXSLP-18-30-18	18"	15.5"	386
FHREXSLP-18-30-24	24"	21.5"	528
FHREXSLP-18-30-30	30"	27.5"	669
FHREXSLP-18-30-36	36"	33.5"	811

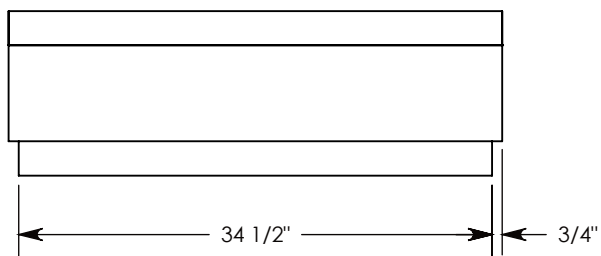

SIDE "A" (HLR)

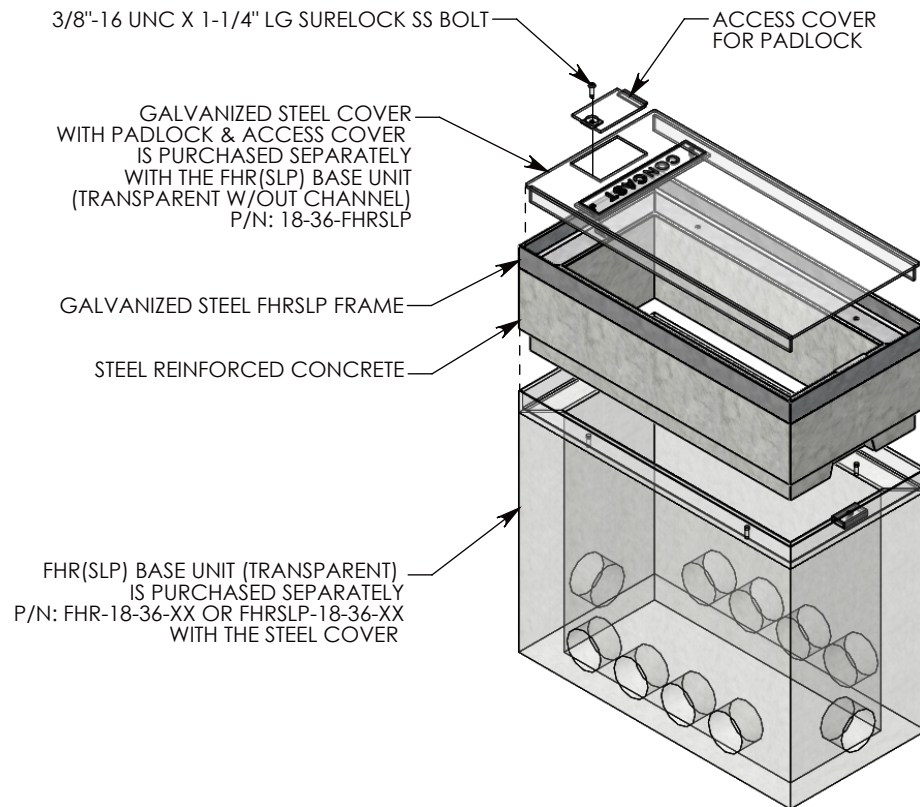
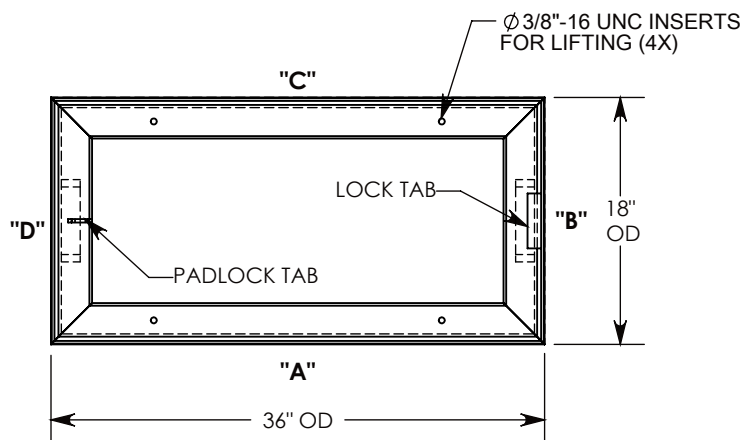
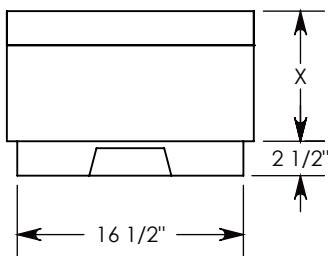

SIDE "B" (HLR)

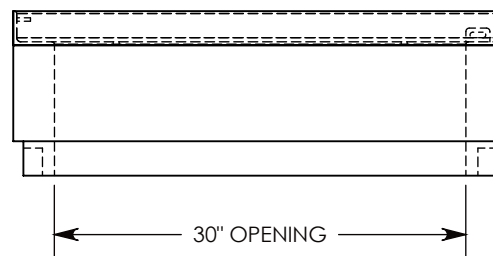

SIDE "C"

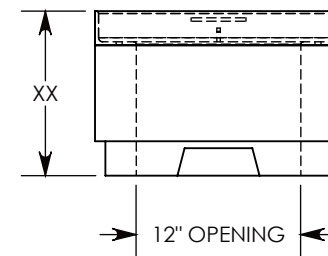

SIDE "D"

H20 RATED - 32,000 LB. PER AXLE LOAD.

DRAWN BY: ROBIN FLINT

DATE: 4/10/2013

REVISION LEVEL: 0

WEIGHT:

NOTED

MATERIAL:

NOTED

CONCAST
 1010 NORTH STAR DRIVE
 P.O. BOX 69
 ZUMBROTA, MN 55992-0069

DESCRIPTION:

PADLOCKING HANDHOLE EXTENSION

DIMENSIONS ARE IN INCHES
 TOLERANCES:
 FRACTIONAL: ± 1/8"
 ANGULAR: ± 2°

CONTACT INFORMATION:
 EMAIL: INFO@CONCASTINC.COM
 PHONE: (507) 732-4095
 FAX: (507) 732-4094

SHEET 1 OF 1

PART NUMBER:

FHREXSLP-18-36-XX