

PART NUMBER	"XX" OVERALL HEIGHT	"X" AMOUNT OF EXTENSION	WEIGHT (POUNDS)
FHREXSLP-24-24-12	12"	9.5"	214
FHREXSLP-24-24-18	18"	15.5"	337
FHREXSLP-24-24-24	24"	21.5"	461
FHREXSLP-24-24-30	30"	27.5"	585
FHREXSLP-24-24-36	36"	33.5"	709

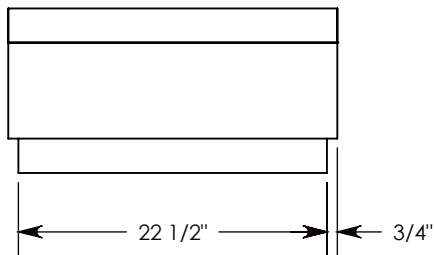

SIDE "A" (HLR)

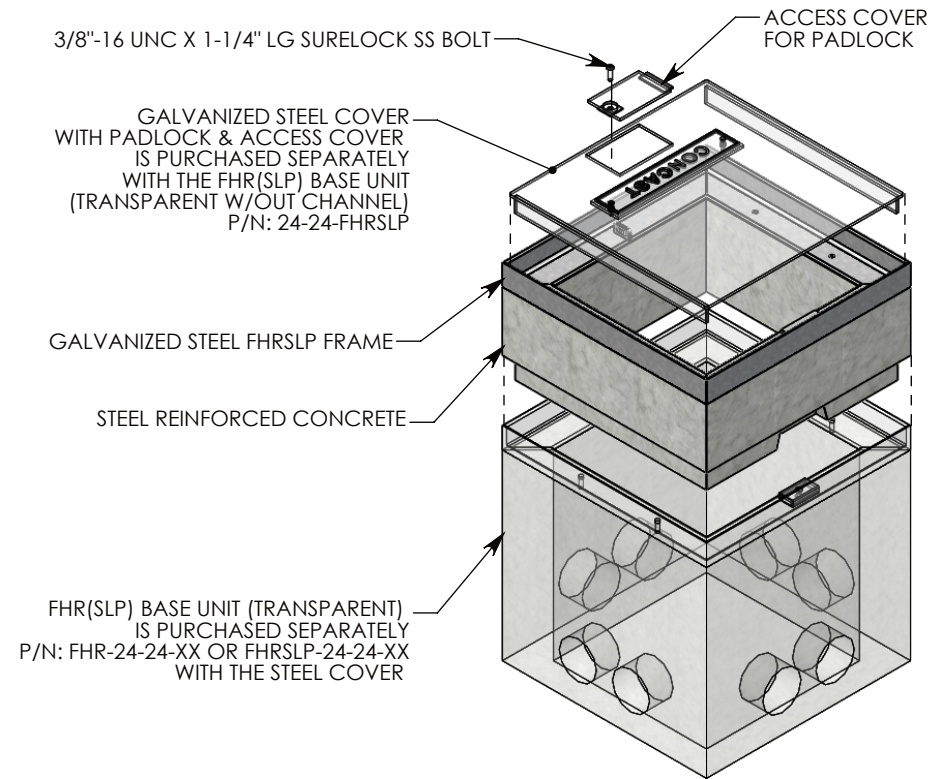
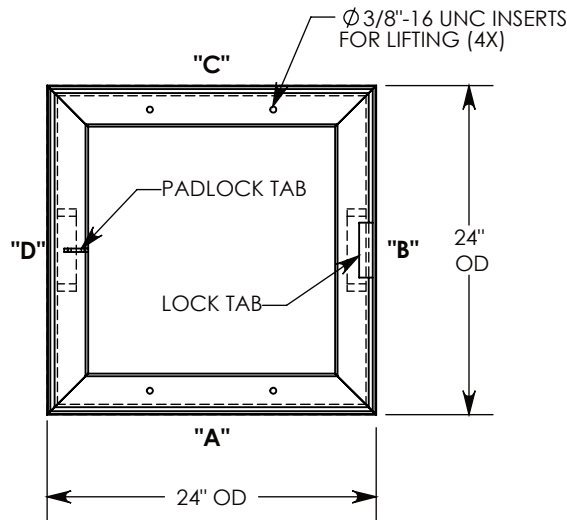
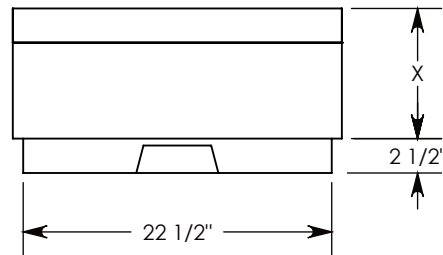

SIDE "B" (HLR)

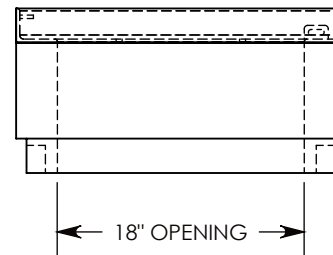

SIDE "C"

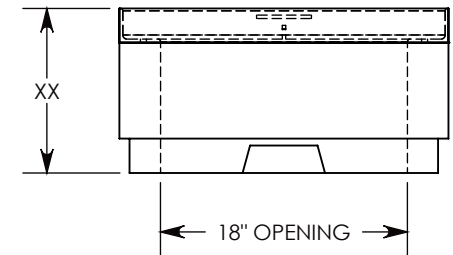

SIDE "D"

H20 RATED - 32,000 LB. PER AXLE LOAD.

DRAWN BY: ROBIN FLINT

DATE: 4/10/2013

REVISION LEVEL: 0

WEIGHT:

NOTED

MATERIAL:

NOTED



DESCRIPTION:

PADLOCKING HANDHOLE EXTENSION

DIMENSIONS ARE IN INCHES
TOLERANCES:
FRACTIONAL: ± 1/8"
ANGULAR: ± 2°

CONTACT INFORMATION:
EMAIL: INFO@CONCASTINC.COM
PHONE: (507) 732-4095
FAX: (507) 732-4094

SHEET 1 OF 1

PART NUMBER:

FHREXSLP-24-24-XX