

**DETAIL E  
SCALE 1 : 8**

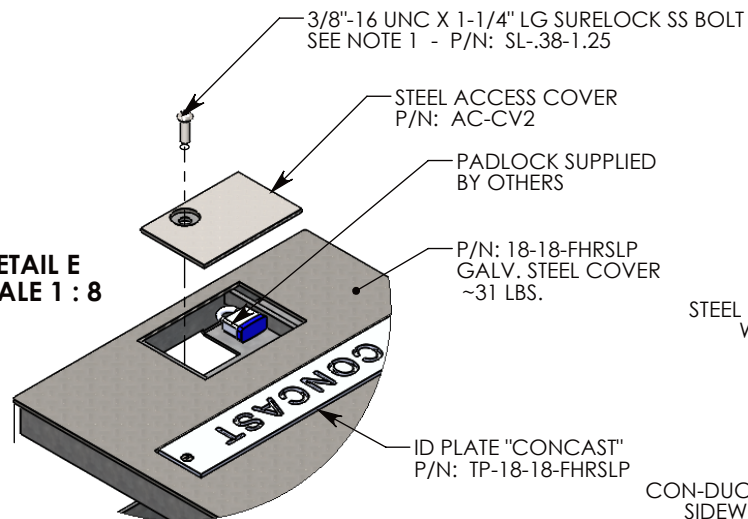

2" ALUMINUM FLOATING NUT  
P/N: FLT-NUT-7

STEEL REINFORCED CONCRETE BASE  
W/CAST-IN GALV. STEEL FRAME  
P/N: FHR-18-18-36-R

CON-DUCT TERMINATIONS ARE CAST INTO BOX SIDEWALLS. THEY FIT UP TO 4" PVC PIPE. TO ACCESS THE HOLES, BREAK PLASTIC SEAL. SEE NOTE 2.

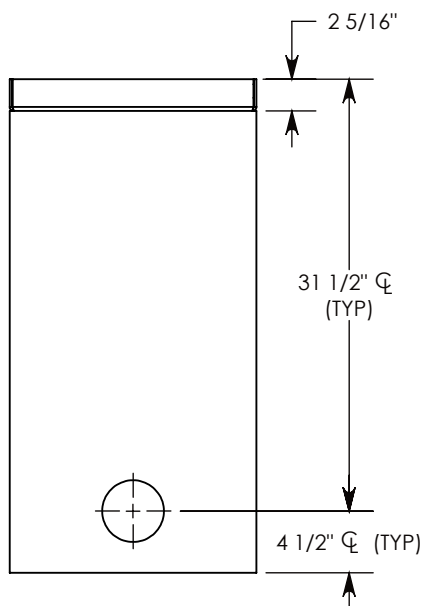
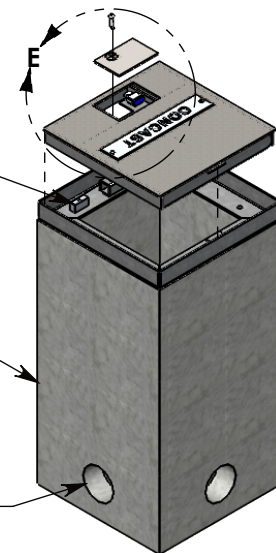

**SIDE "A" (HLR)**

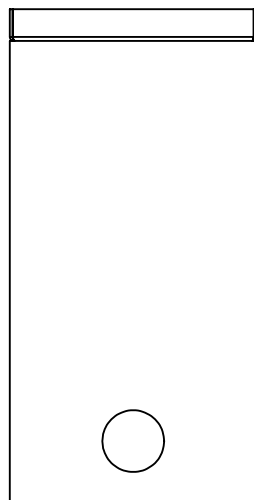

**SIDE "B" HLR**

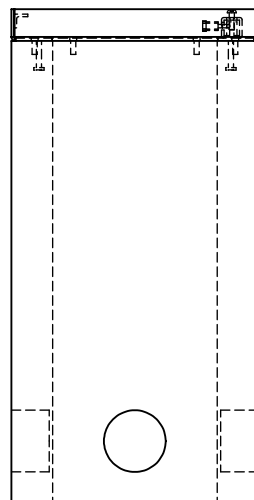

**SIDE "C"**

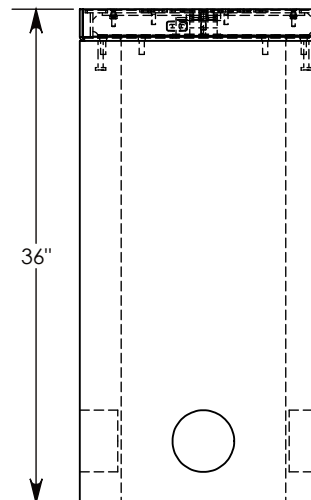

**SIDE "D"**

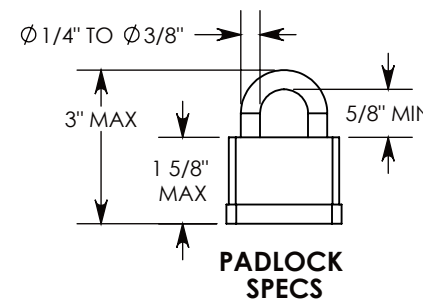

**NOTE 1:** CUSTOM KEYED FOR LOCKING THE ACCESS COVER. SURELOCK BOLT CAN ONLY BE REMOVED BY USING THE CONCAST SUPPLIED TOOL. P/N: 8000SL  
**NOTE 2:** FOR PVC SIZES SMALLER THAN 4", USE CONCAST RC41(REDUING COUPLER).

H2O RATED - 32,000 LB. PER AXLE LOAD.

<b>DRAWN BY: ROBIN FLINT</b>	
<b>DATE: 4/25/2016</b>	<b>REVISION LEVEL: 0</b>
<b>WEIGHT: 532 LBS. W/COVER</b>	<b>MATERIAL: NOTED</b>

1010 NORTH STAR DRIVE  
 P.O. BOX 69  
 ZUMBROTA, MN 55992-0069

<b>DESCRIPTION:</b>		
<b>HEAVY TRAFFIC HANDHOLE</b>		
DIMENSIONS ARE IN INCHES TOLERANCES: FRACTIONAL: $\pm 1/8$ " ANGULAR: $\pm 2^\circ$	CONTACT INFORMATION: EMAIL: INFO@CONCASTINC.COM PHONE: (507) 732-4095 FAX: (507) 732-4094	SHEET 1 OF 1
<b>PART NUMBER:</b>		
<b>FHRSLP-18-18-36</b>		