

REFERENCE ASSEMBLY

FIBERCRETE[®]
TRENCH
SYSTEM

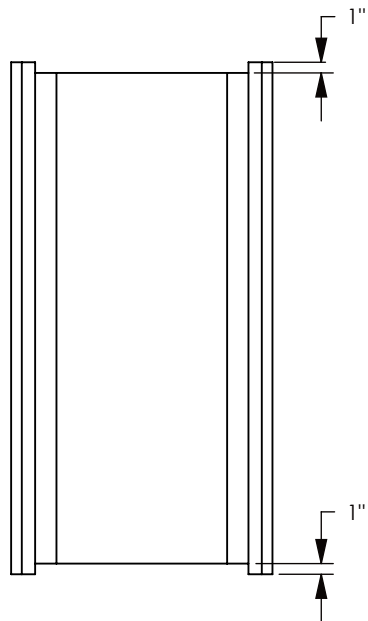

802016HTSG, 802016LT, ETC.
16" INSIDE DEPTH
TRAFFIC RATED CHANNEL
WITH 3 INCH THICK COVER

USE VULKEM POLYURETHANE
SEALANT TO ATTACH & SEAL
THE BULK HEADS TO THE ROAD
CHANNEL WHEN ASSEMBLING
THE TRENCH SYSTEM.

802016F ETC.
16" INSIDE DEPTH
FLUSH PED. CHANNEL

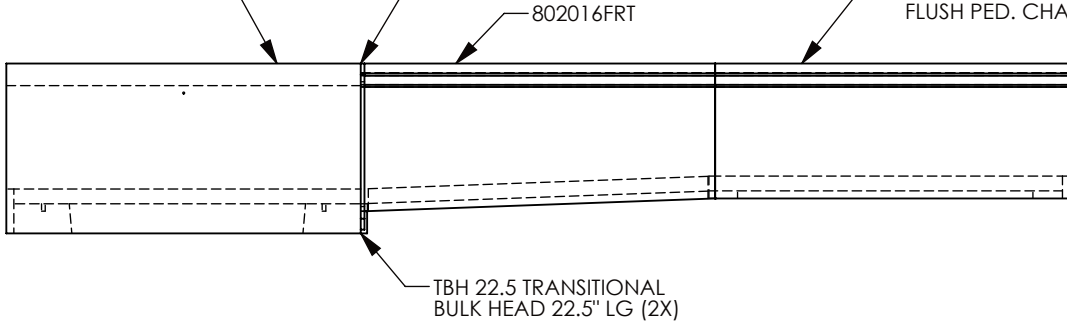

TBH 22.5 TRANSITIONAL
BULK HEAD 22.5" LG (2X)

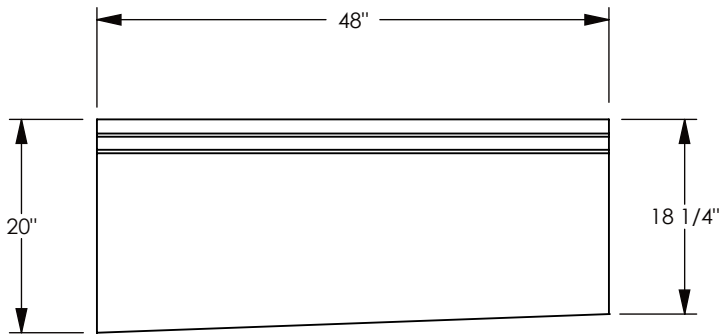
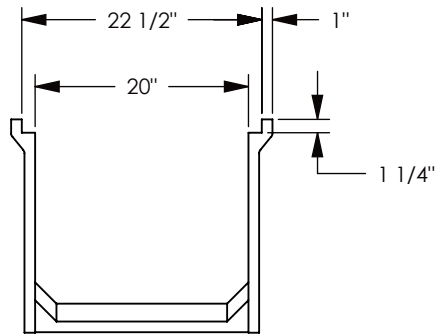

FIBER & STEEL
REINFORCED
CONCRETE

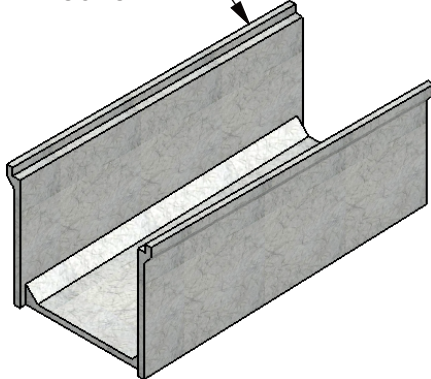

PEDESTRIAN RATED - 200 LB. PER SQ. FOOT

DRAWN BY: ROBIN FLINT

DATE: 12/21/2011

REVISION LEVEL: 0

WEIGHT:

211 LBS.

MATERIAL:

FIBERCRETE

1010 NORTH STAR DRIVE
P.O. BOX 69
ZUMBROTA, MN 55992-0069

DESCRIPTION:

FLUSH TRANSITION CHANNEL

DIMENSIONS ARE IN INCHES
TOLERANCES:
FRACTIONAL: ± 1/8"
ANGULAR: ± 2°

CONTACT INFORMATION:
EMAIL: INFO@CONCASTINC.COM
PHONE: (507) 732-4095
FAX: (507) 732-4094

PART NUMBER: 802016FRT