

FIBERCRETE[®]
TRENCH
SYSTEM

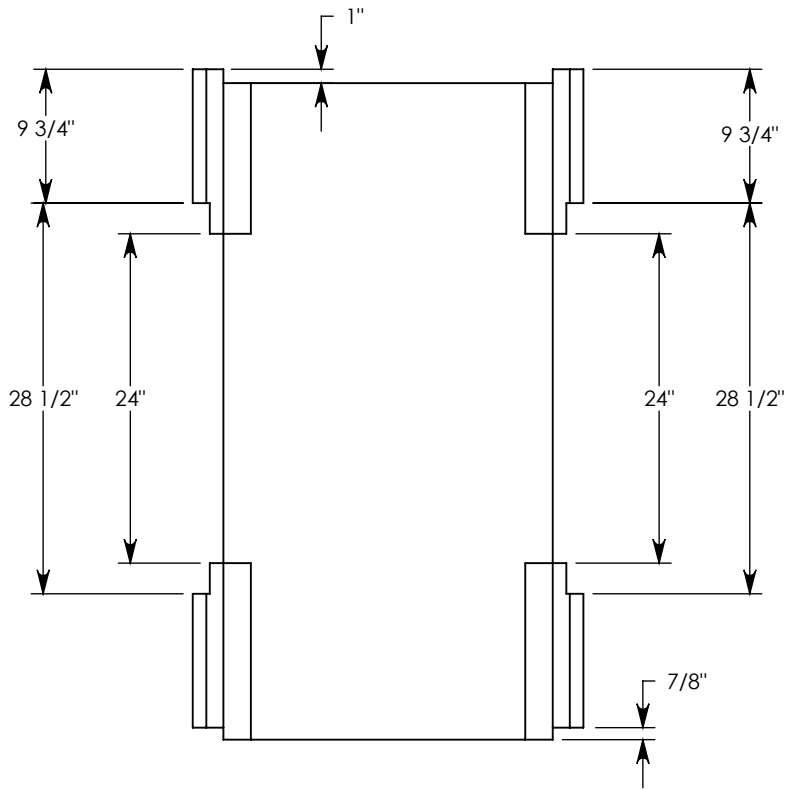

REMOVEABLE ALUM. COVER
 SUPPORT (2X) SHOWN IN
 THIS VIEW ONLY.

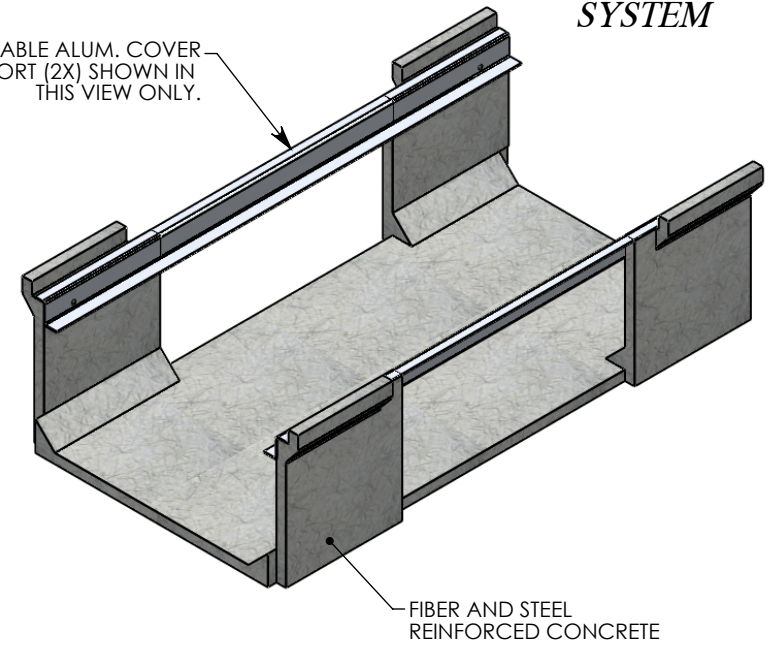

FIBER AND STEEL
 REINFORCED CONCRETE

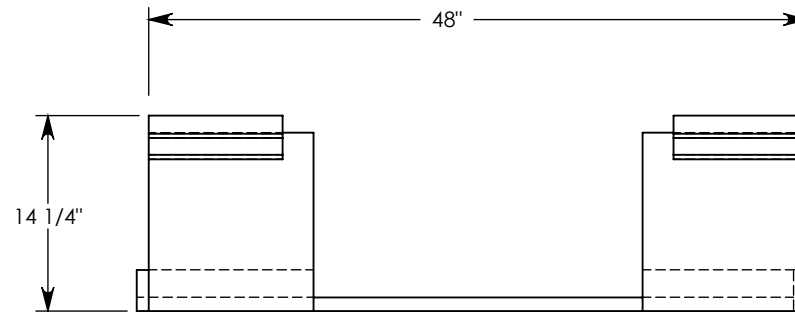
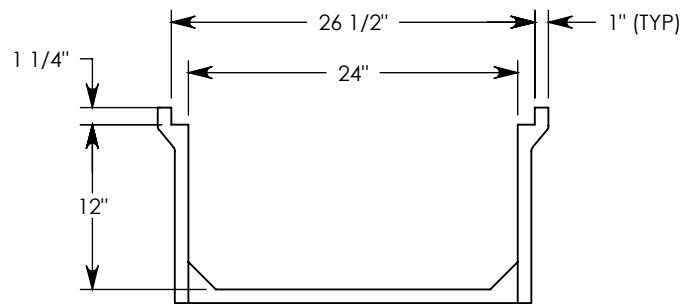

PEDESTRIAN RATED - 200 LB. PER SQ. FOOT

DRAWN BY: ROBIN LEWIS

DATE: 6/9/2011

REVISION LEVEL: 0

WEIGHT:

148 LBS.

MATERIAL:

FIBERCRETE



DESCRIPTION:

FLUSH PEDESTRIAN UNIVERSAL CHANNEL

DIMENSIONS ARE IN INCHES
 TOLERANCES:
 FRACTIONAL: ± 1/8"
 ANGULAR: ± 2°

CONTACT INFORMATION:
 EMAIL: INFO@CONCASTINC.COM
 PHONE: (507) 732-4095
 FAX: (507) 732-4094

SHEET 1 OF 1

PART NUMBER:

8026F (24X24)