

FIBERCRETE[®]
TRENCH SYSTEM

REFERENCE ASSEMBLY

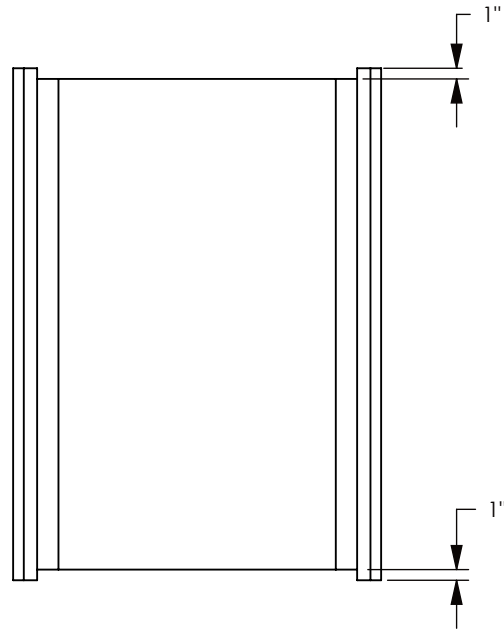

803016HTSG, 803016LT, ETC.
 16" INSIDE DEPTH
 TRAFFIC RATED CHANNEL
 WITH 3 INCH THICK COVER

USE VULKEM POLYURETHANE
 SEALANT TO ATTACH & SEAL
 THE BULK HEADS TO THE ROAD
 CHANNEL WHEN ASSEMBLING
 THE TRENCH SYSTEM.

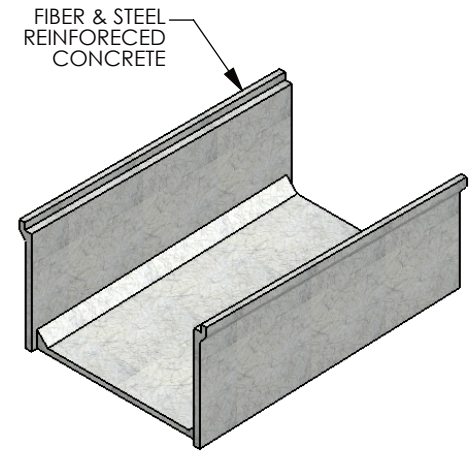
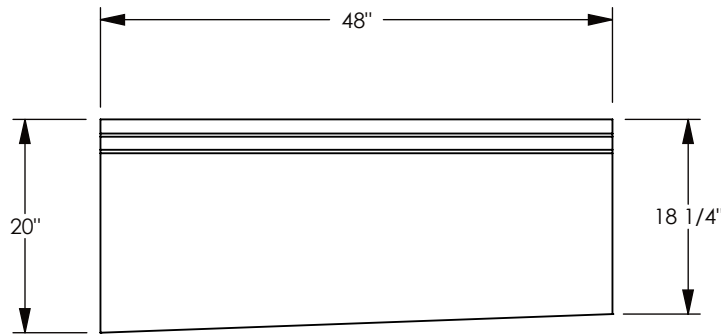
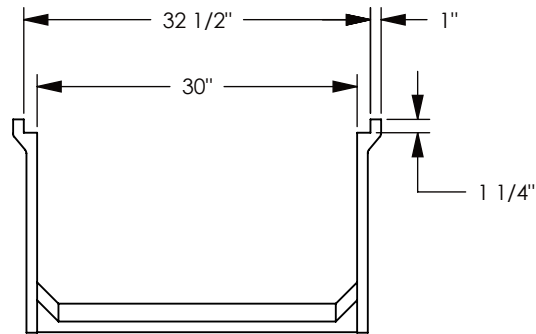
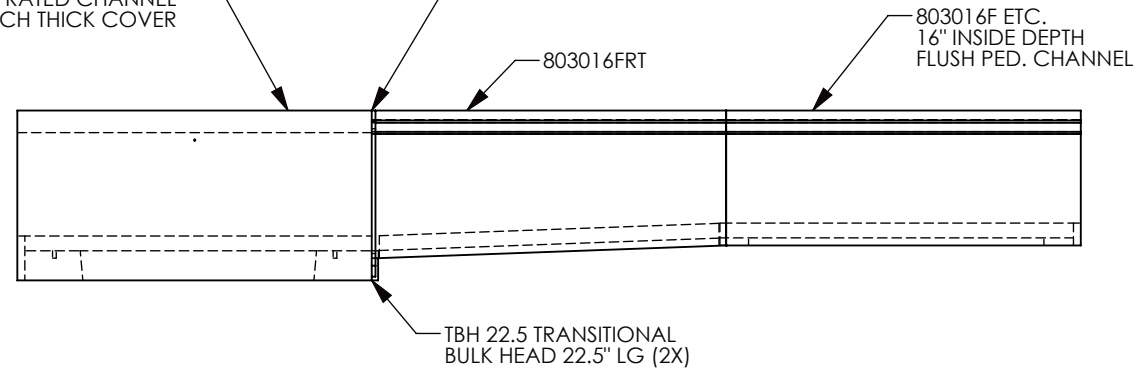

PEDESTRIAN RATED - 200 LB. PER SQ. FOOT

DRAWN BY: ROBIN FLINT

DATE: 12/21/2011

REVISION LEVEL: 0

WEIGHT:

245 LBS.

MATERIAL:

FIBERCRETE

CONCAST
 1010 NORTH STAR DRIVE
 P.O. BOX 69
 ZUMBROTA, MN 55992-0069

DESCRIPTION:

FLUSH TRANSITION CHANNEL

DIMENSIONS ARE IN INCHES
 TOLERANCES:
 FRACTIONAL: ± 1/8"
 ANGULAR: ± 2°

CONTACT INFORMATION:
 EMAIL: INFO@CONCASTINC.COM
 PHONE: (507) 732-4095
 FAX: (507) 732-4094

PART NUMBER: 803016FRT

SHEET 1 OF 1