

REFERENCE ASSEMBLY

FIBERCRETE[®]
TRENCH SYSTEM

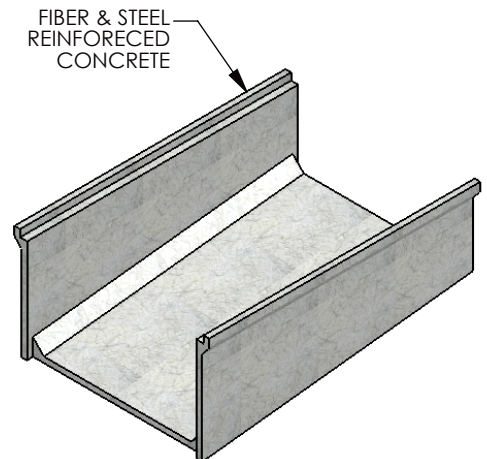
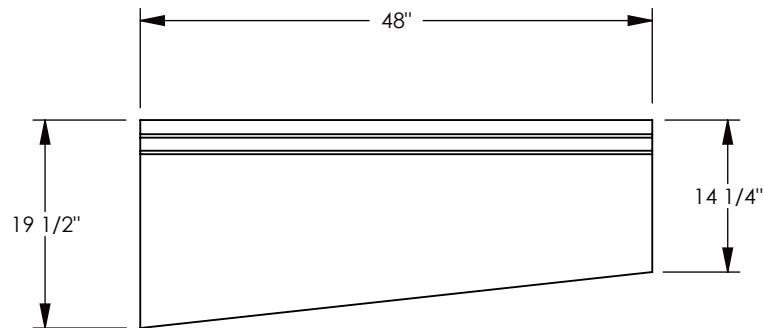
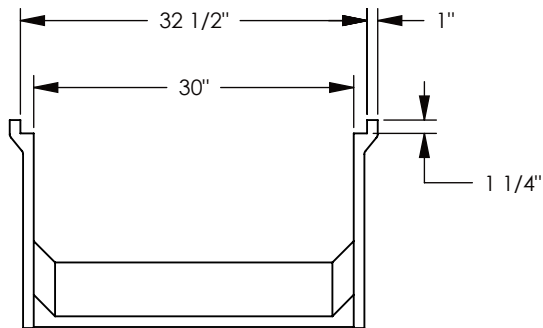
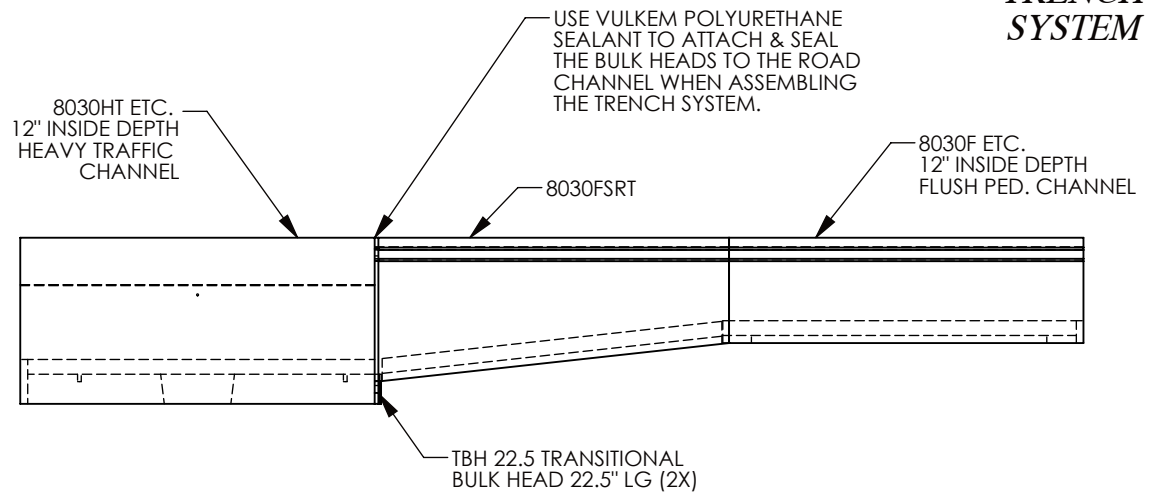
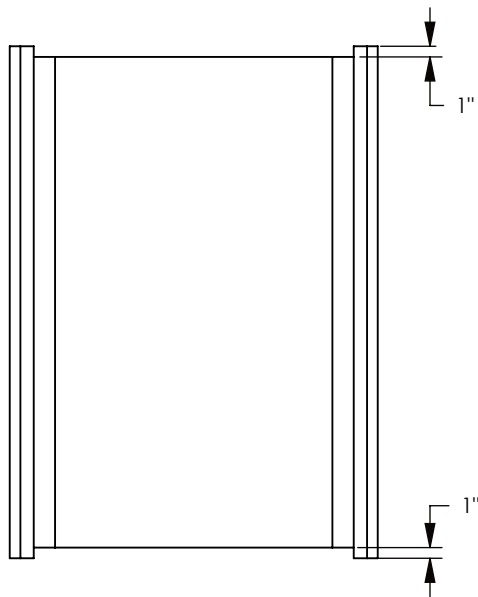

PEDESTRIAN RATED - 200 LB. PER SQ. FOOT

DRAWN BY: ROBIN FLINT

DATE: 12/21/2011

REVISION LEVEL: 0

WEIGHT:

229 LBS.

MATERIAL:

FIBERCRETE

CONCAST
1010 NORTH STAR DRIVE
P.O. BOX 69
ZUMBROTA, MN 55992-0069

DESCRIPTION:

FLUSH TRANSITION CHANNEL

DIMENSIONS ARE IN INCHES
TOLERANCES:
FRACTIONAL: ± 1/8"
ANGULAR: ± 2°

CONTACT INFORMATION:
EMAIL: INFO@CONCASTINC.COM
PHONE: (507) 732-4095
FAX: (507) 732-4094

PART NUMBER: 8030FSRT

SHEET 1 OF 1