

FIBERCRETE[®]
TRENCH
SYSTEM

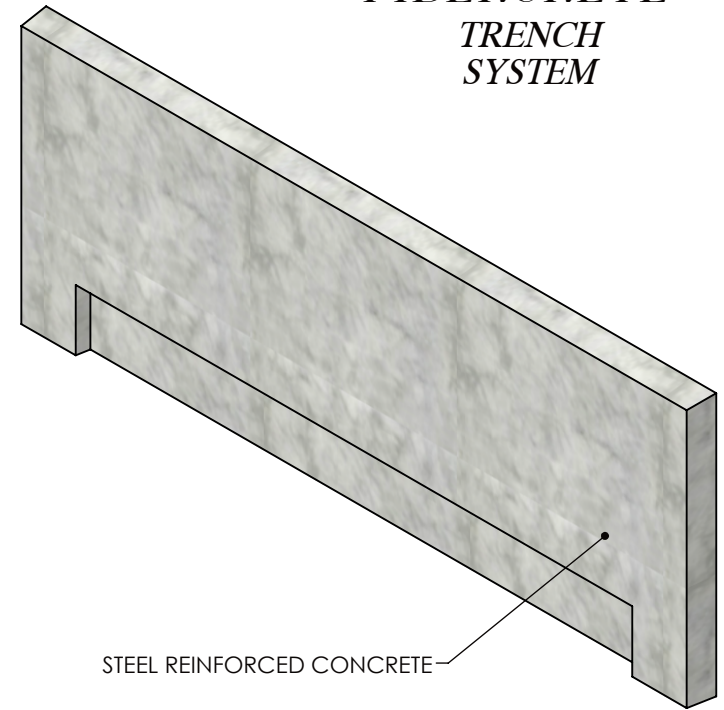
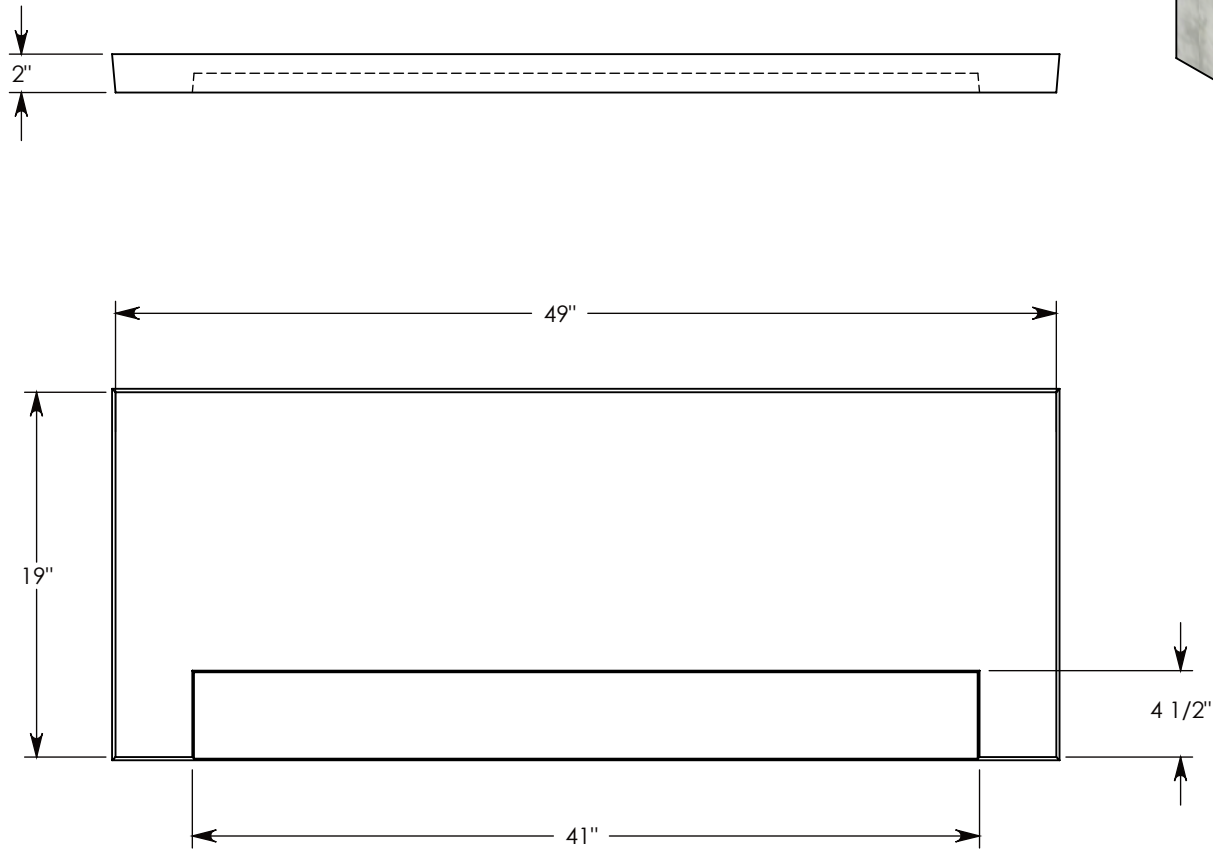

STEEL REINFORCED CONCRETE

H-20 RATED - 32,000 LB. PER AXLE LOAD.

DRAWN BY: ROBIN FLINT

DATE: 6/10/2015

REVISION LEVEL: 0

WEIGHT:

139 LBS.

MATERIAL:

CONCRETE



1010 NORTH STAR DRIVE
 P.O. BOX 69
 ZUMBROTA, MN 55992-0069

DESCRIPTION:

HEAVY TRAFFIC END PLATE

DIMENSIONS ARE IN INCHES
 TOLERANCES:
 FRACTIONAL: ± 1/8"
 ANGULAR: ± 2°

CONTACT INFORMATION:
 EMAIL: INFO@CONCASTINC.COM
 PHONE: (507) 732-4095
 FAX: (507) 732-4094

SHEET 1 OF 1

PART NUMBER:

8043HT3