

**FIBERCRETE<sup>®</sup>**  
**TRENCH**  
**SYSTEM**

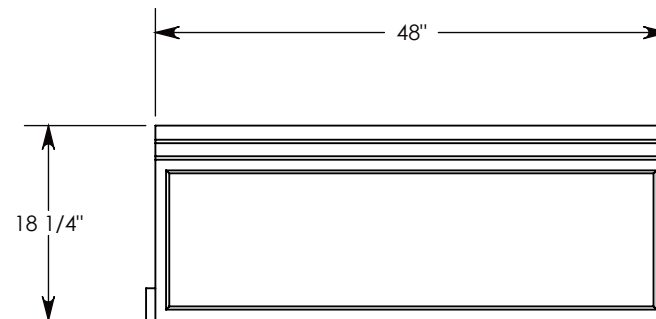
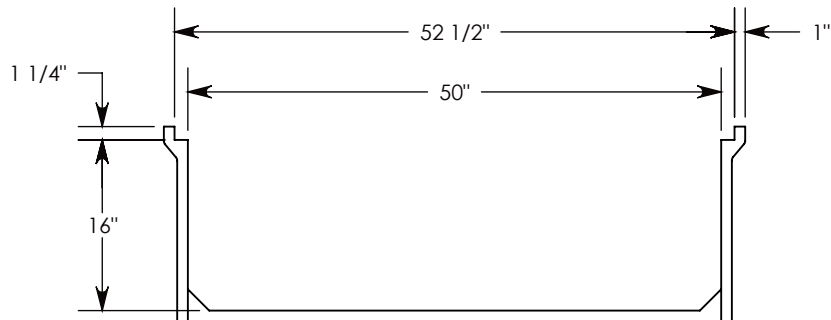
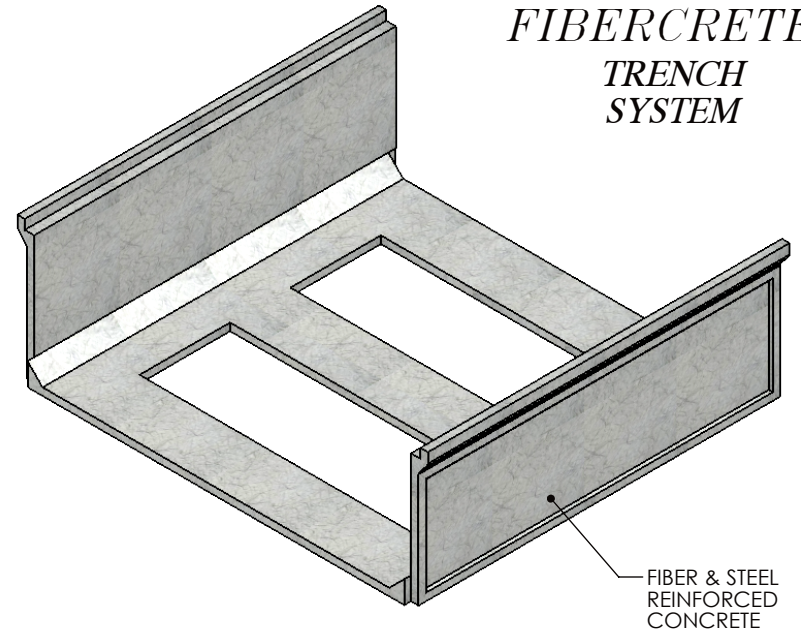
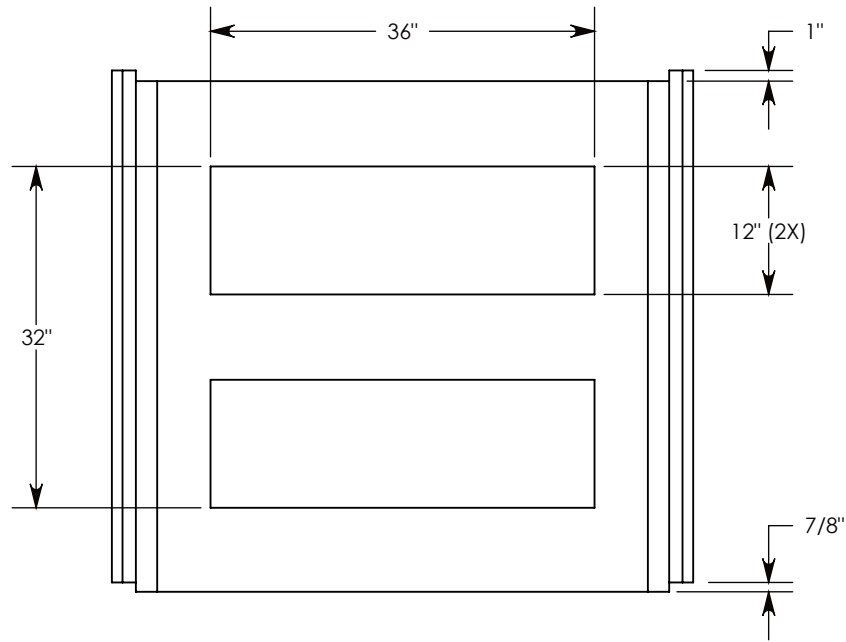

NOTE: FOR NON-STANDARD LENGTHS THE CHANNEL WILL BE SOLID BOTTOM AND DESIGNATED WITH ITS CORRESPONDING LENGTH MEASUREMENT. IE: 805016F 32"

PEDESTRIAN RATED - 200 LB. PER SQ. FOOT

**DRAWN BY: ROBIN LEWIS**

**DATE: 2/23/2017**

**REVISION LEVEL: 0**

**WEIGHT:**

**238 LBS.**

**MATERIAL:**

**NOTED**



**DESCRIPTION:**

**FLUSH PEDESTRIAN CHANNEL**

DIMENSIONS ARE IN INCHES  
 TOLERANCES:  
 FRACTIONAL: ± 1/8"  
 ANGULAR: ± 2°

CONTACT INFORMATION:  
 EMAIL: INFO@CONCASTINC.COM  
 PHONE: (507) 732-4095  
 FAX: (507) 732-4094

SHEET 1 OF 1

**PART NUMBER:**

**805016F**