

FIBERCRETE®

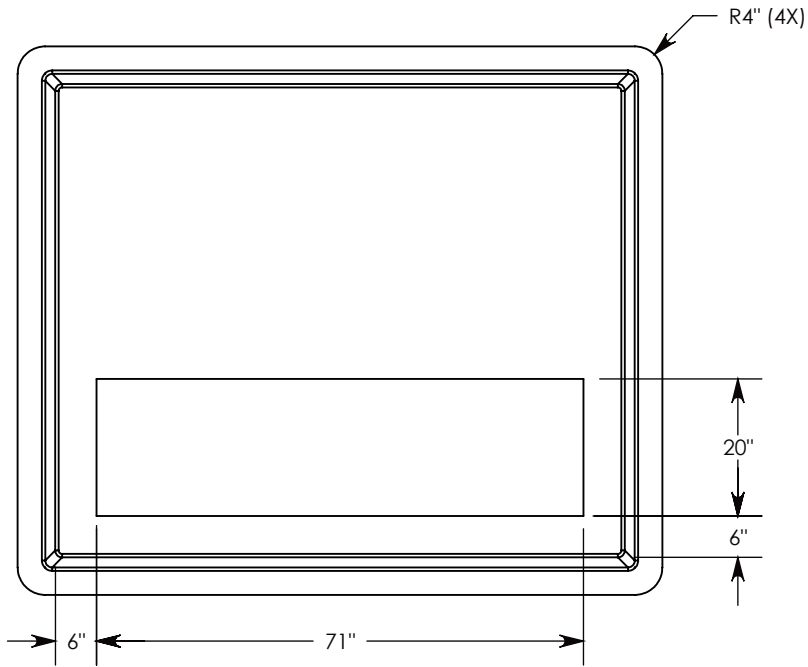

FIBER REINFORCED CONCRETE

EXCLUDING THE FINS, THE REAR TRANSFORMER SUPPORT MUST BE WITHIN 6" OF THIS EDGE.

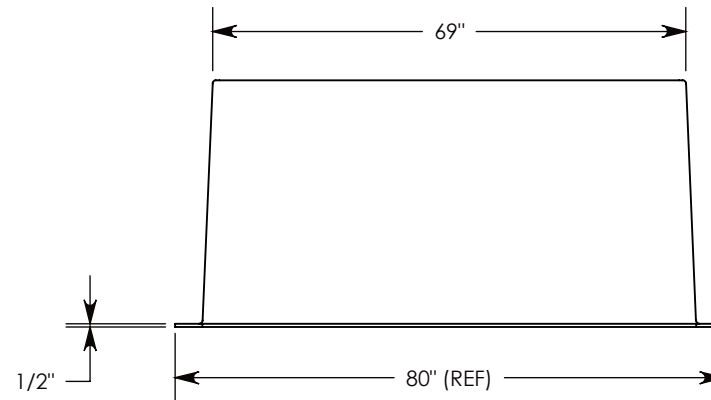
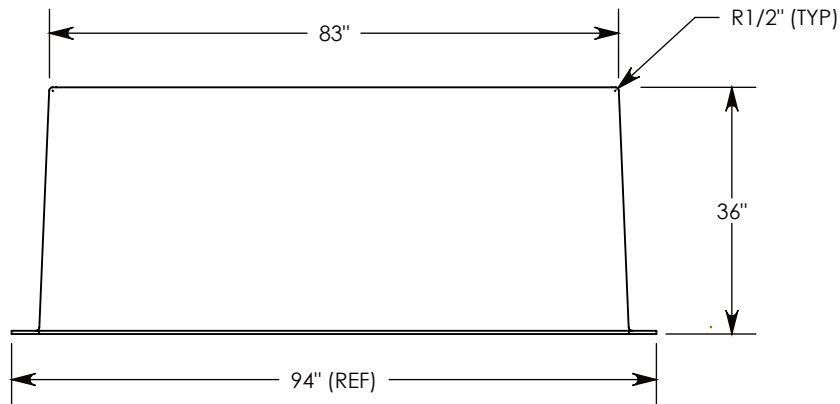
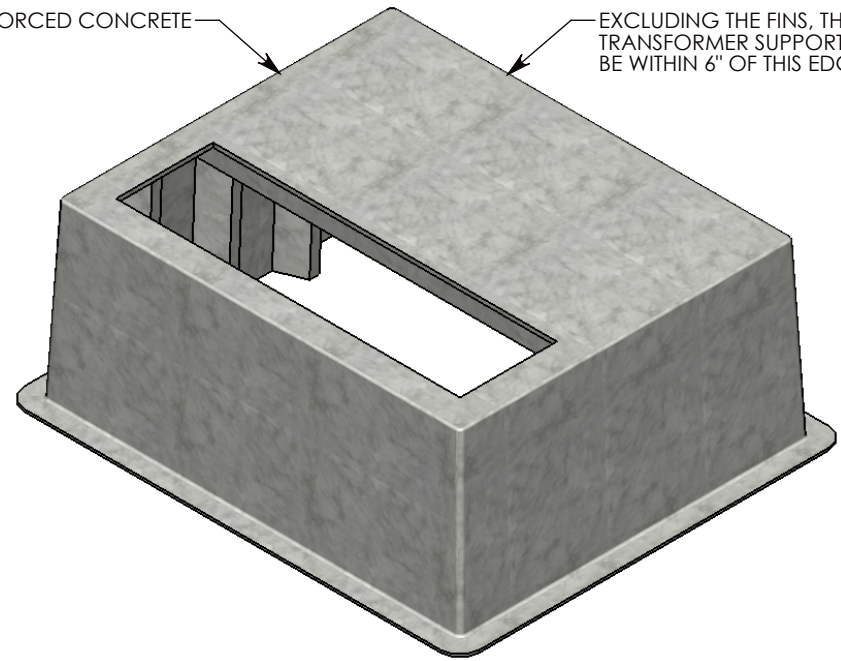

DRAWN BY: ROBIN FLINT

DATE: 6/21/2013

REVISION LEVEL: 0

WEIGHT:

1157 LBS.

MATERIAL:

FIBERCRETE FC



1010 NORTH STAR DRIVE
P.O. BOX 69
ZUMBROTA, MN 55992-0069

DESCRIPTION:

FIBERCRETE BOX PAD

DIMENSIONS ARE IN INCHES
TOLERANCES:
FRACTIONAL: ± 1/8"
ANGULAR: ± 2°

CONTACT INFORMATION:
EMAIL: INFO@CONCASTINC.COM
PHONE: (507) 732-4095
FAX: (507) 732-4094

SHEET 1 OF 1

PART NUMBER:

FC-69-83-36-2071 (6)