

FIBERCRETE®

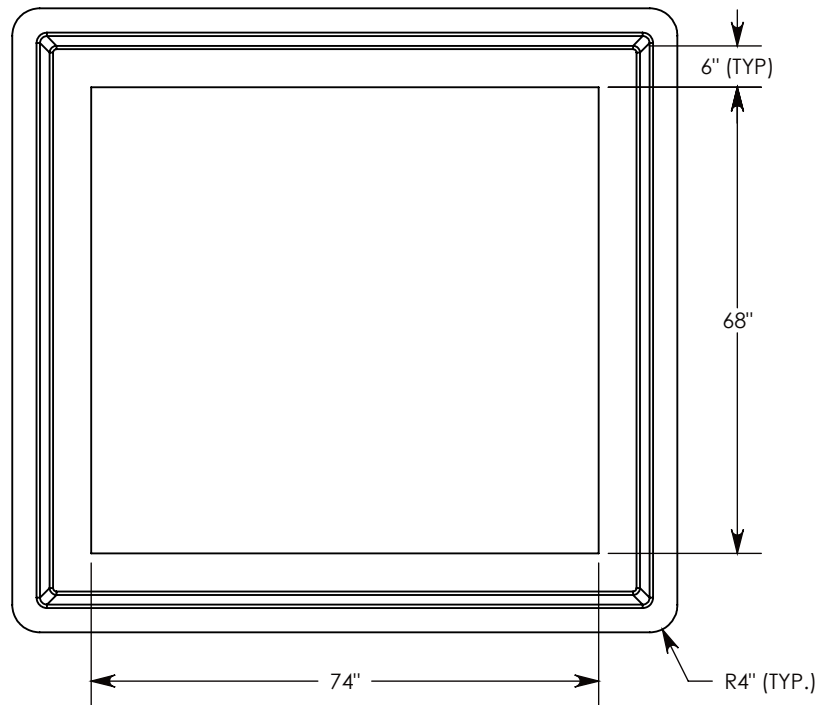

FIBER REINFORCED CONCRETE

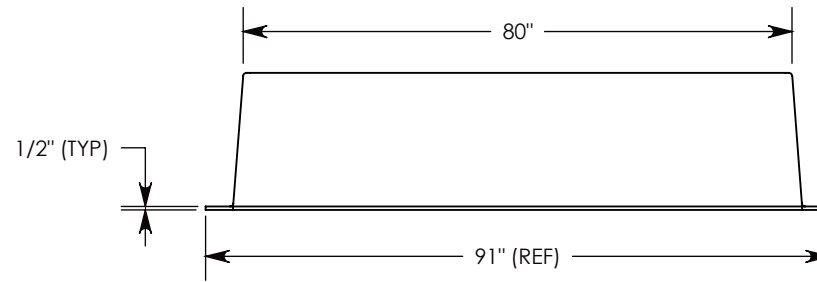
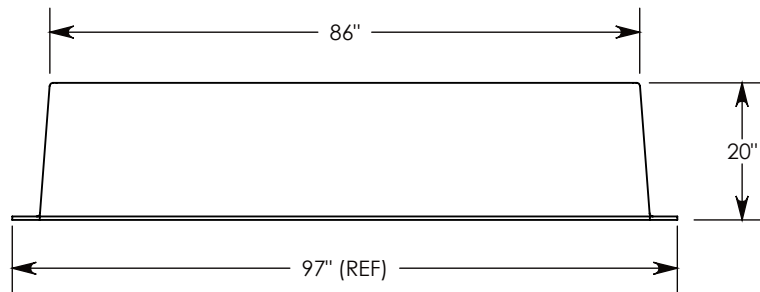
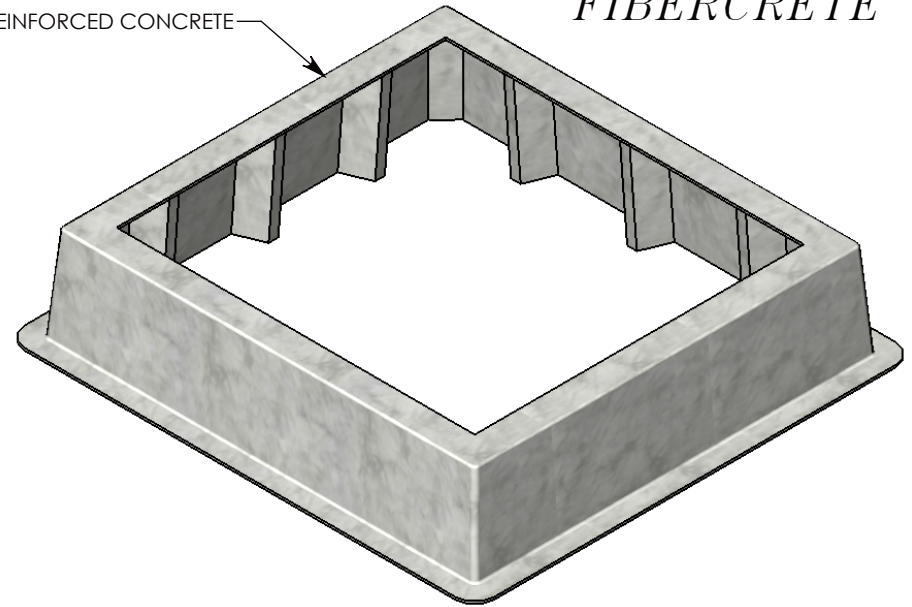

DRAWN BY: ROBIN FLINT

DATE: 2/3/2012

REVISION LEVEL: 0

WEIGHT:

557 LBS.

MATERIAL:

FIBERCRETE FC



1010 NORTH STAR DRIVE
P.O. BOX 69
ZUMBROTA, MN 55992-0069

DESCRIPTION:

FIBERCRETE BOX PAD

DIMENSIONS ARE IN INCHES
TOLERANCES:
FRACTIONAL: $\pm 1/8"$
ANGULAR: $\pm 2^\circ$

CONTACT INFORMATION:
EMAIL: INFO@CONCASTINC.COM
PHONE: (507) 732-4095
FAX: (507) 732-4094

SHEET 1 OF 1

PART NUMBER:

FC-80-86-20-6874