

ITEM NO.	PART NUMBER	DESCRIPTION	QTY.
1	CCSCREW-1.25	1/4" X 1.25" LONG CONCRETE SCREW	8
2	DIV-BKT.W	1/2" ALUMINUM SLEEVE	4
3	FHR-18-30-DIV.B	FHR DIVIDER BOARD	1

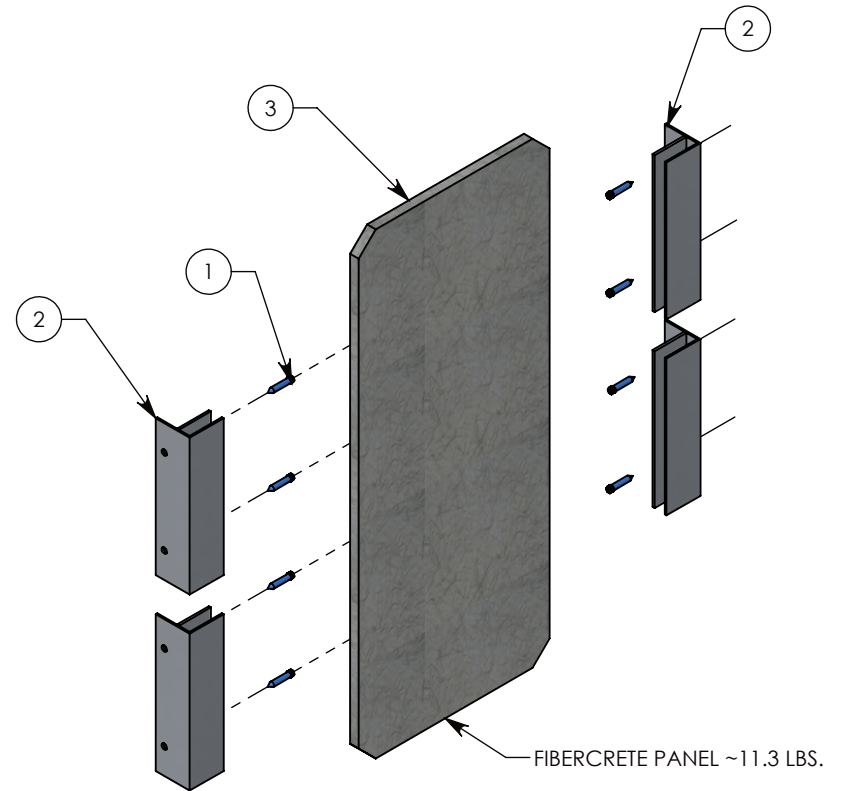
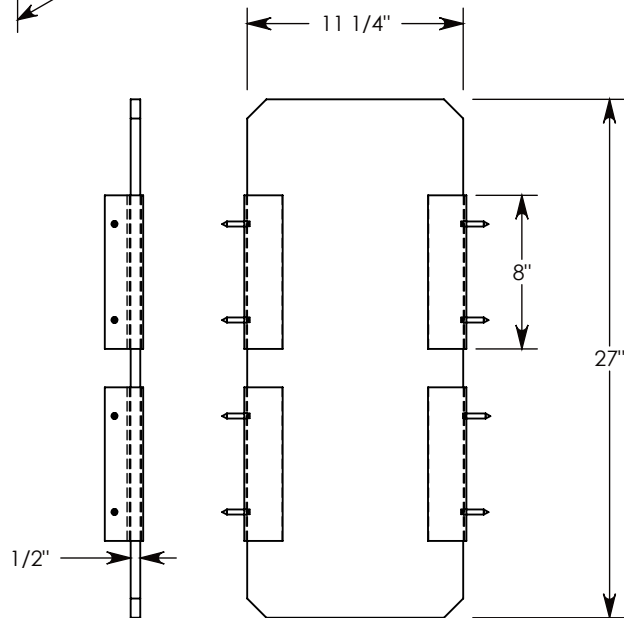

**NOTE:** DESIGNED TO CREATE SEPARATION IN A 18" WIDE BY 30" TALL CONCAST FHR HANDHOLE UNIT.

**DRAWN BY:** ROBIN FLINT

**DATE:** 10/31/2015

**REVISION LEVEL:** 0

**WEIGHT:**  
13 LBS.  
WITH HARDWARE

**MATERIAL:**  
NOTED



**DESCRIPTION:**

**FHR DIVIDER PANEL**

DIMENSIONS ARE IN INCHES  
TOLERANCES:  
FRACTIONAL: ± 1/8"  
ANGULAR: ± 2°

CONTACT INFORMATION:  
EMAIL: INFO@CONCASTINC.COM  
PHONE: (507) 732-4095  
FAX: (507) 732-4094

SHEET 1 OF 1

**PART NUMBER:**

**FHR-18-30-DIV**